

Custom

CABINETRY by LIOHER

SPECBOOK & PRICE LIST

Made in USA 

Need samples?



DESIGN YOUR **DREAMS**

ABOUT

ABOUT US

LIOHER Corp, offers high quality furniture components. Since its founding in 2010, Lioher has geared itself into offering a big range of products and solutions:

- Modern and technologically advanced boards in stock: the LUXE, ZÉNIT and SYNCRON.
- A leading door production program, which uses state-of-the-art cutting and edge banding technologies
- The best kitchen box on the market, the AQUABOX
- A Network of production and distribution facilities in USA with stock processing machinery, logistics, and full equipped showrooms for a better service to our professional clients.

This mix of knowledge and experience is what allow us to build a cabinetry line that truly understands the needs of our customers. Our mission is to become your best partner.

QUALITY

We start by producing our own surfaces (boards) with unique finishes and patented processes. We produce all the doors and drawer fronts with the most advanced cut and edgebanding technologies, barcoding systems for traceability of every item. Finally, we have selected only high quality accessories and hardware from the best brands worldwide. This is our strategy (and the only one possible) to secure a consistent quality standard and long-term satisfaction to our customers.

MADE IN USA

While many companies label their products as Built in USA or Assembled in USA (Meaning sourced outside USA), we are a vertically integrated manufacturer that has invested heavily in US. Our surfaces and doors are produced in the US as well as all the services such as assembly. Our boxes (the Aquabox) are still produced in our European facilities while we work on creating the conditions to begin the production in US.

WARRANTY & SERVICE

We stand behind everything we do, and we offer a convenient way to report any claim or problem.

Our products are rigorously tested and produced upon the strict quality protocols. Our quality standards are certified by industry-recognized testing associations, so we know that our products are built to last. This is why we offer a 5-year warranty on all our products.

We believe a product is only as good as the service that supports it, and we have a great team of experienced cabinet professionals ready to hear your concerns and answer your questions. Most importantly we listen to the input our customers give us and make sure your suggestions are addressed as we continually seek ways to better serve you.

HOW TO...

OPEN AN ACCOUNT

Just simply visit our website at www.loher.com and send your application. We'll provide a response to your application request within 48 hours.



PLACE AN ORDER

Place your order conveniently by either filling our order forms or using the 2020Design platform.

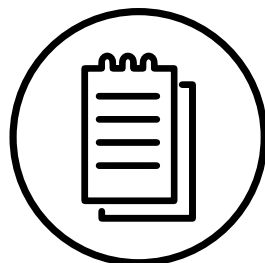

2020 Design

ORDER SAMPLES AND CATALOGS

We put a lot of effort in the supporting sales tools available to you. From cost, to functionality, flexibility, design and information, we have created in the most comprehensive set of tools you can have.

All sales tools are in stock and conveniently available to purchase online through our website.



PROGRAM OVERVIEW

DOORS

200+
door options



3 advanced
finishes

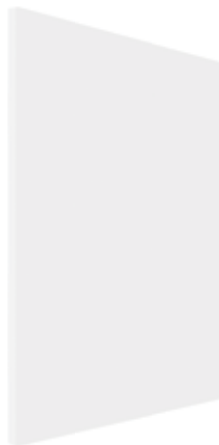

Luxe
by ALNIC
High-Resistance Product
Lacquered High Gloss

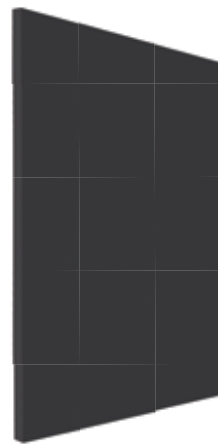

Zénit
High-Resistance Surface
Lacquered Super Matt



Syncron
structured panel LINE
Deep Texture

3 convenient
formats



flatte
F



Finger-Pull
Integrated handle



CAVA
LUCHE

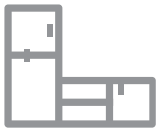

BOXES



AQUABOX[®] by LIOHER

The best box in the market

Solid construction

18 mm sides and 8 mm back panel with back rail

Aluminium rail

Soft grey linen design

Thermofused melamine both inside and outside

Moisture resistant core

Paired with concealed edges, it protects against most extreme humidity

Antibacterial

Kills 99.99% of bacteria and microbes and subdues the growth of mold and fungus

Full access / frameless

Clip Toe Kick

Quick assembly system

4.5" From Cabinet to floor

Protection of the cabinet against floods

Adjustable legs

For convenient leveling



PROGRAM OVERVIEW



HARDWARE

Premium hardware



Blum Soft closing

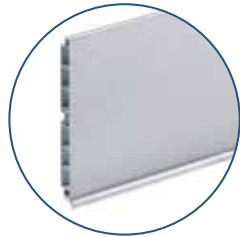

Matching Toe kick
or PVC



Spice Rack

Upgrades



Trash pull out

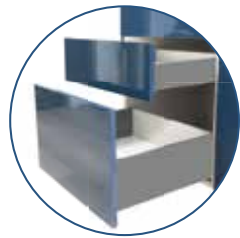

Evolution Drawers



Blum Drawers



LEAD TIME & DELIVERY

Delivery available & 4 - 6 weeks lead time





RANGE & OPTIONS

700+ cabinets & Assembly included



Gola & Pull



3 Heights

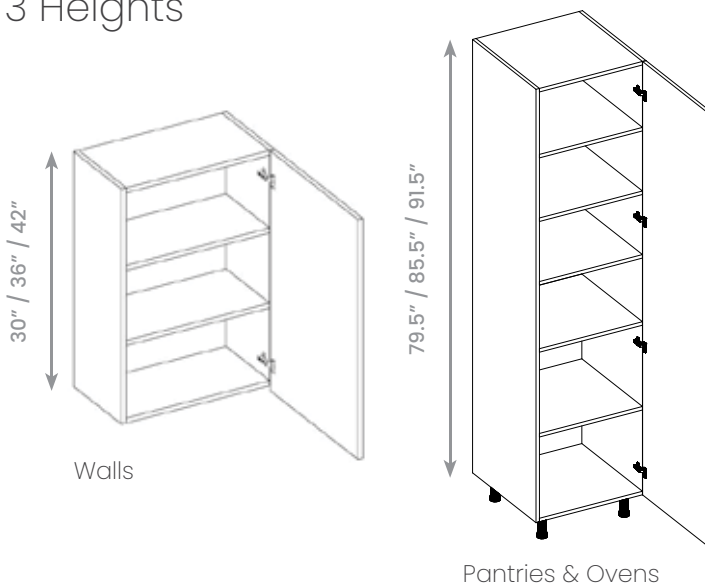

360° Modifications available

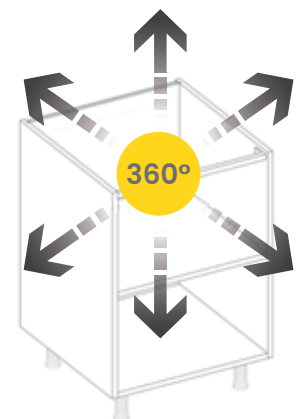

DOORS

DESIGNS





NATURA • C1

FLATTE® doors - Slab.

Made with **SYNCRON**® Texture surface, manufactured in 3/4" (18mm) Particle Board.

Antibacterial treated and Carb-2 formaldehyde release (TSCA-IV).

Matching design edge in 1mm thickness.

* Double side texture for eligible designs

NATURA CRONO • C2

FLATTE® doors - Sequence Slab.

The natura collection with sequenced grain

Syncron®
structured panel LINE

Como Ash 3



Ice 1



Ice 2



Ice 3



Ice 4



Texture finish: Ice



Evora 3

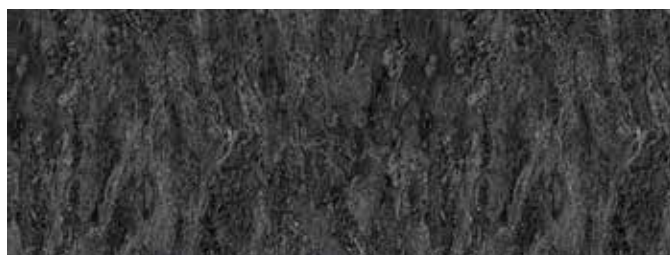

Evora 4



Texture finish: Jade



Ida 1



Ida 2



Ida 3



Ida 4



Texture finish: **Rustik**



Olmo 1



Olmo 2



Olmo 3



Texture finish: **Jerez**



Muratti 1

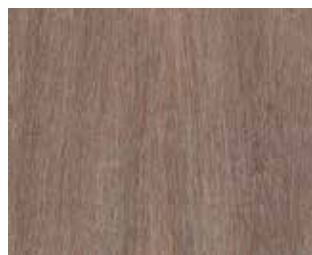

Muratti 2

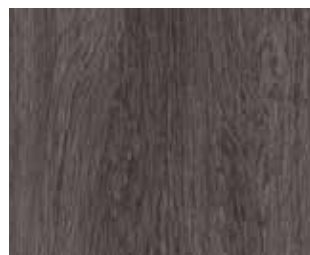

Muratti 3



Muratti 4



Texture finish: **Muratti**



Frappé 1



Frappé 2



Frappé 3



Texture finish: **Frappé**



Oxid 1



Oxid 4



Texture finish: **Silk Stone**



Blanco Solid Wood



Cashmere Solid Wood



Basalto Solid Wood



Gris Plomo Solid Wood



Antracita Solid Wood

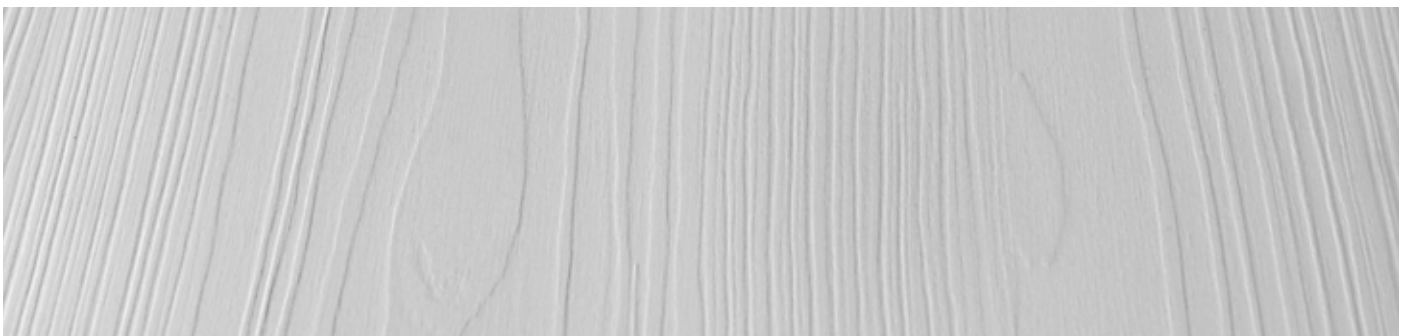

Texture finish: **Jerez**



Lakeland Oak 1



Lakeland Oak 2



Lakeland Oak 3



Texture finish: **Sierra**



Nocce 1

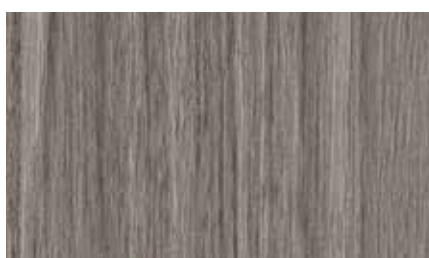

Nocce 2



Nocce 3



Texture finish: **Highland**



Caroline Pine Rustic



Texture finish: **Rustik**



Anniversary Oak 1



Anniversary Oak 2

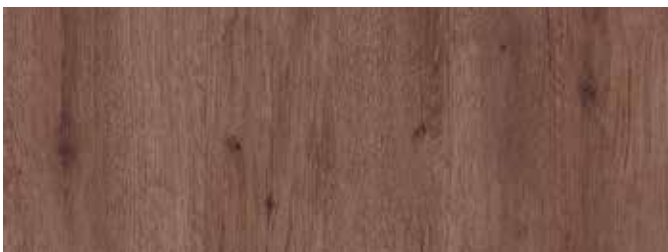

Anniversary Oak 3



Texture finish: **Register**



Art Oak 1

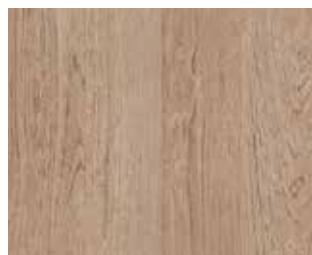

Art Oak 2



Art Oak 3



Art Oak 4



Texture finish: Register



Como Ash 1



Como Ash 2



Como Ash 3



Texture finish: Register

Custom

CABINETRY by LOHER



C1 • C2





VITRA • C3

FLATTE® doors - High gloss Slab.

Made with **LUXE**® lacquered surface, manufactured in 3/4" (18mm) Medium Density Fiberboard (MDF).

Antibacterial treated and Carb-2 formaldehyde release (TSCA-IV).

Matching design edge in 1 mm thickness.

VITRA DUO • C3



FLATTE® doors - High gloss dual edge Slab.

The Vitra Collection with Dual color edge.

VITRA CRONO • C4



FLATTE® doors - High gloss sequence grain slab.

The Vitra Collection with sequence grain.

NOTE: Vitra Duo & Crono are optional and only available for those finishes with the mark.

Luxe®
by **ALVIC**
PATENTED PRODUCT
Rojo

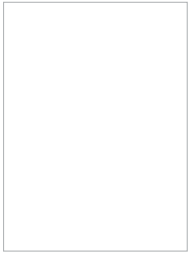

Blanco

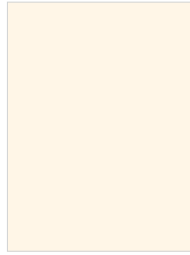

Magnolia



Cashmere



Basalto



Lava



Gris Metallic

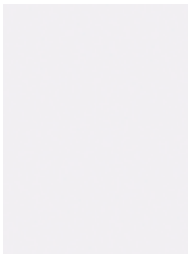

Blanco Polar

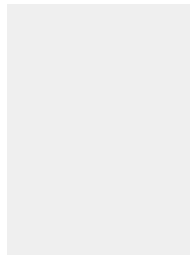

Perla

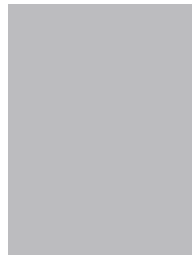

Gris Nube 03



Gris Plomo



Antracita

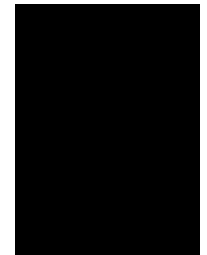

Black



Rojo



Curry



Azul Índigo





Oriental White

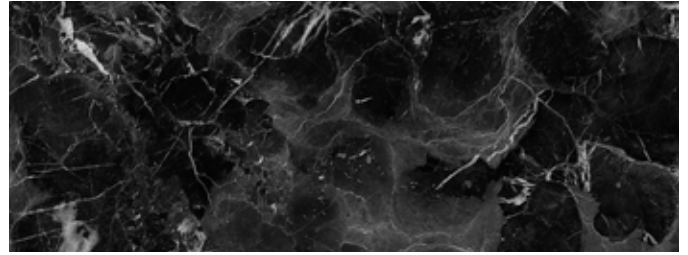

Oriental Black

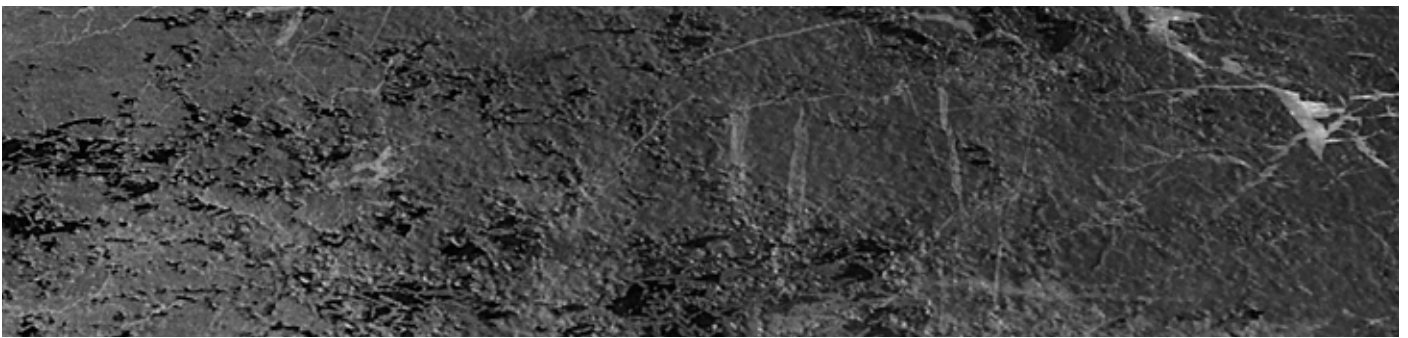

Metallo 1



Metallo 2



Metallo 4





Cuzco Oro



Cuzco Copper



Textil Plata

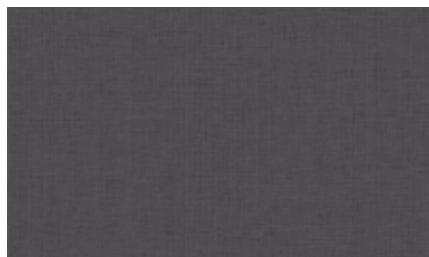

Textil Grafito



Textil Oro

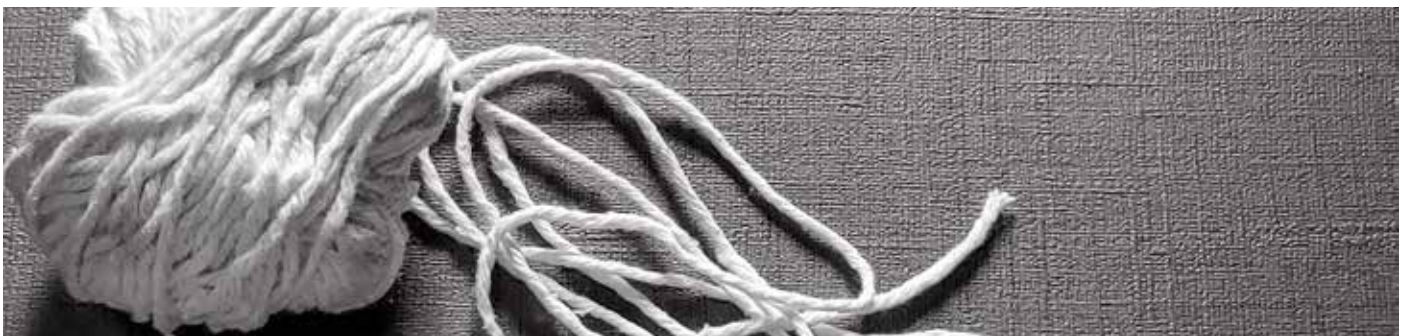



Láser Blanco ● ●



Euroline 3 ● ●



Guayana ● ●



Art Oak ●



Olivo ●



Olmo ● ●



Roble Frappé ● ●



C3 . C4





PEARL • C3

**FLATTE® doors - High gloss
Pearl Slab.**

Made with **LUXE®** Pearl Effect finish
lacquered surface, manufactured in 3/4"
(18mm) Medium Density
Fiberboard (MDF).

Antibacterial treated and Carb-2
formaldehyde release (TSCA-IV).

Matching design edge in 1mm thickness.

Luxe®
by **ALVIC**
PATENTED PRODUCT
Pearl Effect / Cobalto

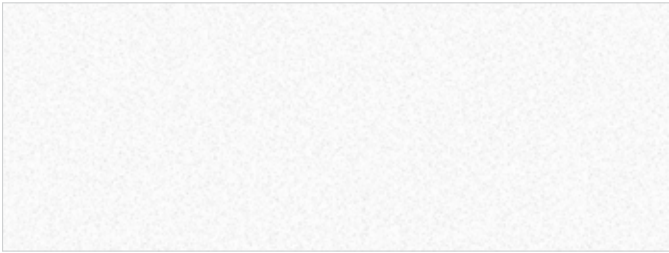

Blanco Colonial Pearl Effect



Cobalto Pearl Effect



Basalto Pearl Effect



Antracita Pearl Effect



Custom
CABINETS by LOHER







ZEN • C3

FLATTE doors - Super Matt Slab.

Made with **ZENIT**® lacquered surface, manufactured in 3/4" (18mm) Medium Density Fiberboard (MDF).

Carb-2 formaldehyde release (TSCA-IV).

Matching design edge in 1mm thickness.

Zénit
High Resistance Surface
Antracita

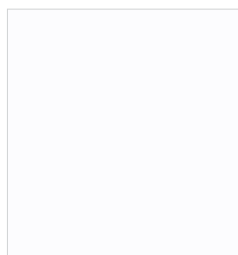

Supermatt Blanco Polar

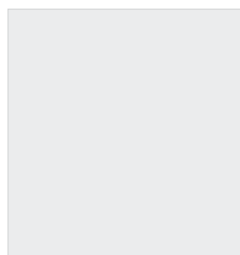

Supermatt Gris Perla

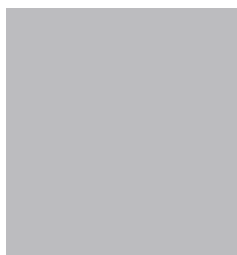

Supermatt Gris Nube



Supermatt Gris Plomo



Supermatt Antracita

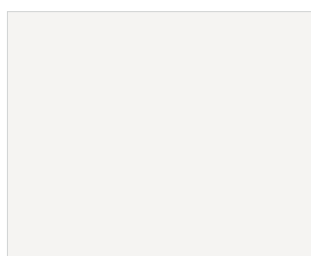

Supermatt Blanco



Supermatt Cashmere



Supermatt Basalto

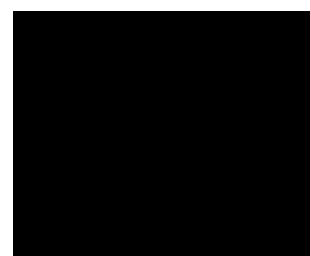

Supermatt Black



Supermatt Agua Marina



Supermatt Azul Índigo





Supermatt Oriental White

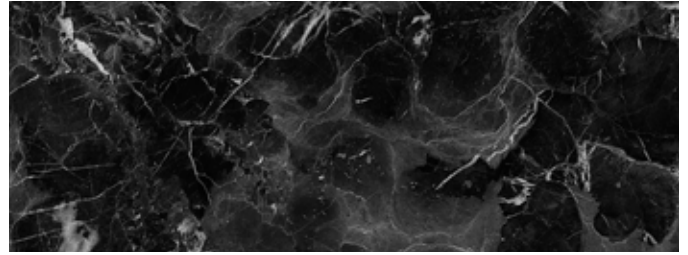

Supermatt Oriental Black

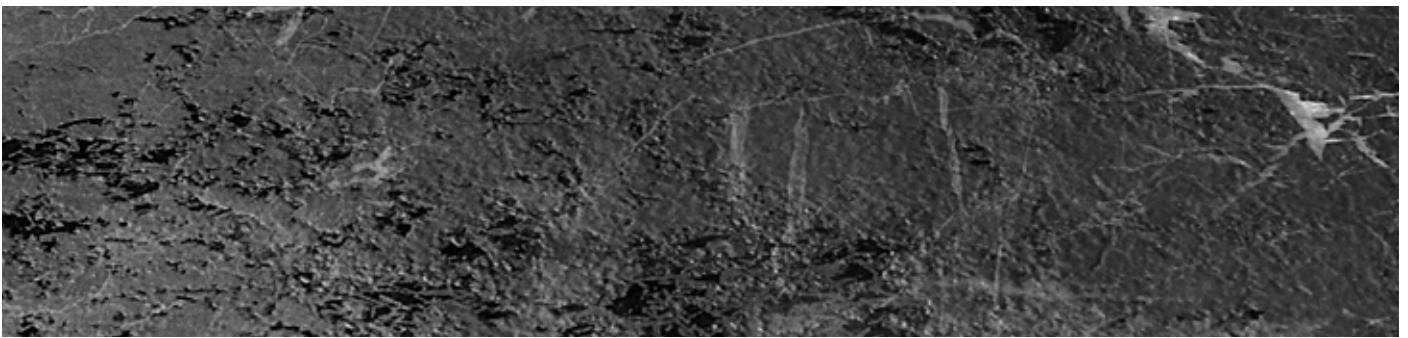

MetalDeco Antracita SM

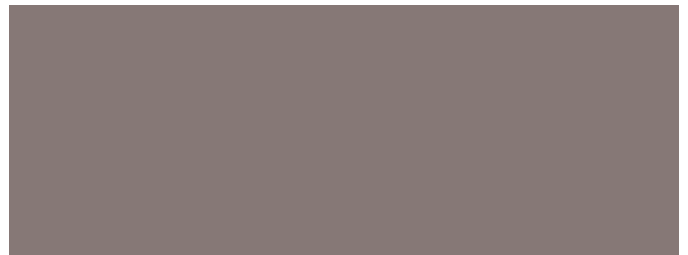

MetalDeco Basalto SM



C3



Custom
CABINETS by LOHER







VITRA PLUS • C4

**FLATTE doors - Premium High
gloss Slab.**

Made with **LUXE PLUS**® Next generation
lacquered surface, manufactured in 3/4"
(18mm) Medium Density
Fiberboard (MDF).

Antibacterial treated and Carb-2
formaldehyde release (TSCA-IV).

Matching design premium acrylic edge
in 1mm thickness.

VITRA PLUS ● CRONO • C6

**FLATTE doors - Premium High gloss
Sequence Grain Slab.**

The vitra plus collection with
sequence grain.



Steelboard Grafito

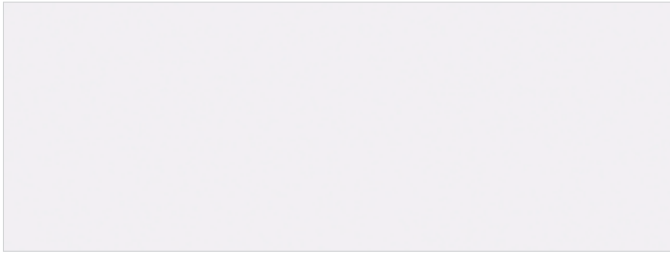

Blanco Polar



Agua Marina



Lenox Plata



Steelboard Aluminio



Steelboard Grafito





C4 . C6





CAVA • C5

CAVA doors - Texture Shaker.

Made with **SYNCRON**® Texture surface, manufactured in Particle board with 3/4" (18mm) for the rails and 5/16" (8mm) for the center panel.

Antibacterial treated and Carb-2 formaldehyde release (TSCA-IV).

Matching design edge in 1mm thickness.

* Double side texture for eligible designs.

CAVA®
by LOHER

SYNCRON / Como Ash 2

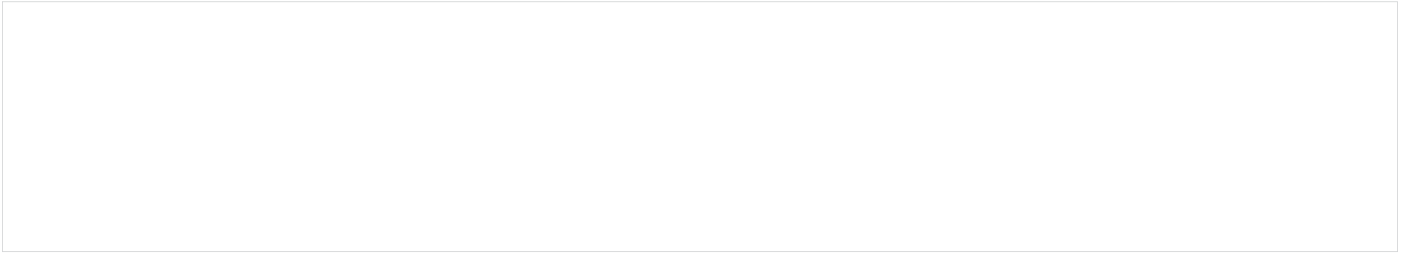

Blanco fino





Ida 1



Ida 2



Ida 3



Ida 4



Texture finish: Rustic



Olmo 2



Olmo 3



Texture finish: **Jerez**



Muratti 4



Muratti 1



Muratti 2



Muratti 3



Texture finish: **Muratti**



Frappé 1



Frappé 2



Frappé 3



Texture finish: **Frappé**



Anniversary Oak 1



Anniversary Oak 2

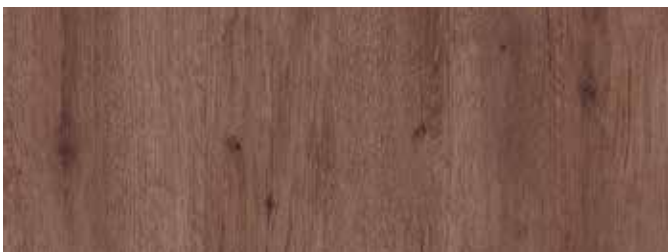

Anniversary Oak 3



Texture finish: **Register**



Art Oak 1



Art Oak 2



Art Oak 3



Art Oak 4



Texture finish: Register



Como Ash 1



Como Ash 2



Como Ash 3



Texture finish: Register



DS	Thelma's	Signature COFFEES	Ice de
\$5.50		Latte + Cappuccino	Haagen Dazs Ice
\$4.50		Latte \$3.20 grande \$3.75 venti \$4.65	Ben & Jerry's Indiv
\$8.50		Espresso	Raspberry Chees
\$4.50		single \$1.75 double \$2.00	Salted Turtle Br
\$4.00		Caramel + White Chocolate	Gourmet Candy
		Macchiato	Jumbo Thelma's
		Latte \$3.65 grande \$4.35 venti \$4.75	BEVER:
		extra flavoring .504 per shot	Ice Tea \$2.00
			Soda \$2.00
			Vitamin
			Bottled
			Hot Chi



CAVA ZEN • C6

CAVA doors - Super Matt Shaker.

Made with **ZÉNIT**® Lacquered surface, manufactured in Medium Density Fiberboard (MDF) with 3/4" (18mm) for the rails and 5/16" (8mm) for the center panel.

Carb-2 formaldehyde release (TSCA-IV).

Matching design edge in 1mm thickness.

CAVA®
by LOHER

ZÉNIT / Basalto

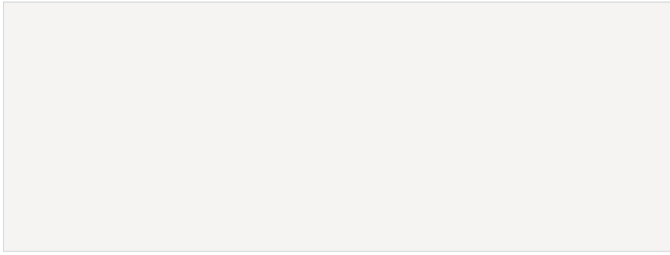

Supermatt Blanco



Supermatt Cashmere

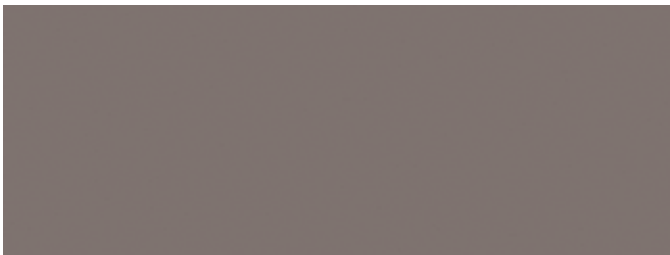

Supermatt Basalto



Supermatt Antracita



Custom
CABINETS by LOHER







PULL NATURA • C7

FINGER PULL doors - Texture Pull.

Made with **SYNCRON**® Texture surface, manufactured in a J pull with 7/8" (22mm) Particle Board.

Antibacterial treated and Carb-2 formaldehyde release (TSCA-IV).

Matching design edge in 1mm thickness.

Finger-Pull

Integrated handle

SYNCRON / Muratti 4



Muratti 4



Muratti 1



Olmo 3



Nocce 1



Custom

CABINETS BY LOHER







PULL VITRA • C8

FINGER PULL doors - High Gloss Pull.

Made with **LUXE**® lacquered surface, manufactured in a J pull with 7/8" (22mm) Medium Density Fiberboard (MDF).

Antibacterial treated and Carb-2 formaldehyde release (TSCA-IV).

Matching design edge in 1mm thickness.

PULL ZEN • C8

FINGER PULL doors - Super Matt Pull

Made with **ZENIT**® lacquered surface, manufactured in a J pull with 7/8" (22mm) Medium Density Fiberboard (MDF).

Carb-2 formaldehyde release (TSCA-IV).

Matching design edge in 1mm thickness.

Finger-Pull

Integrated handle

Zénit / Antracita

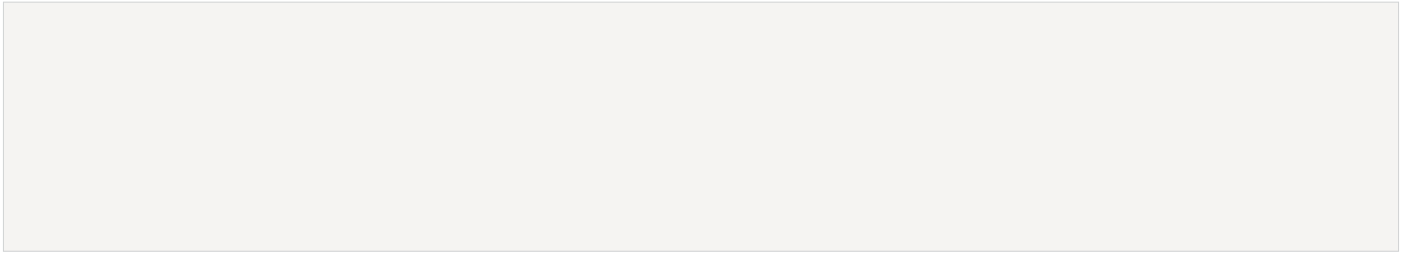

Blanco



Antracita







MODU

LATION

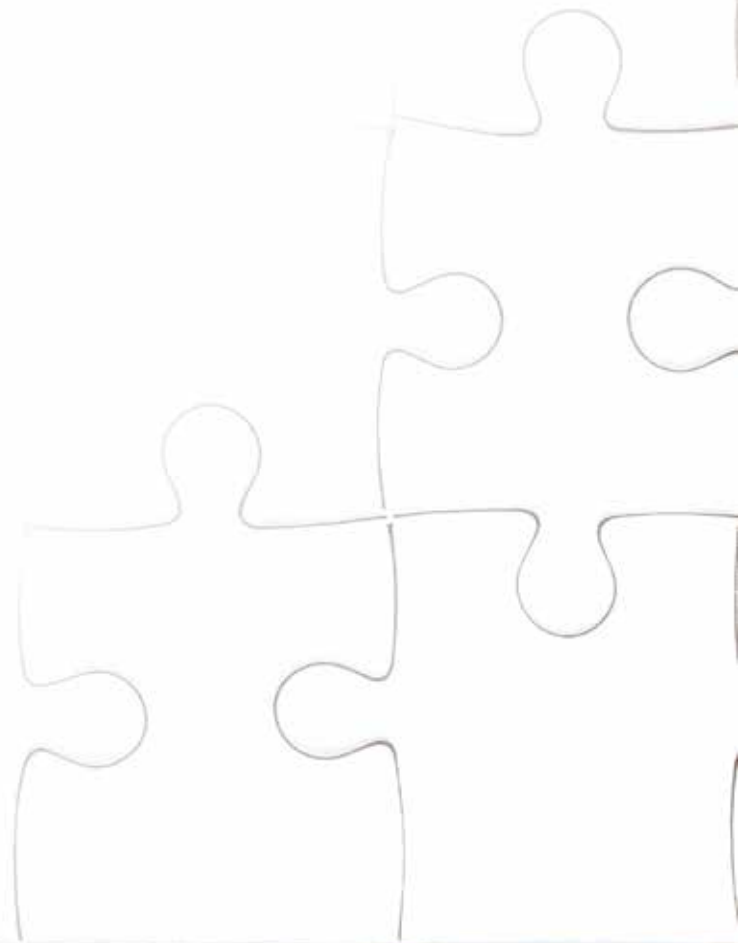

Custom
CABINETS BY LIOHER

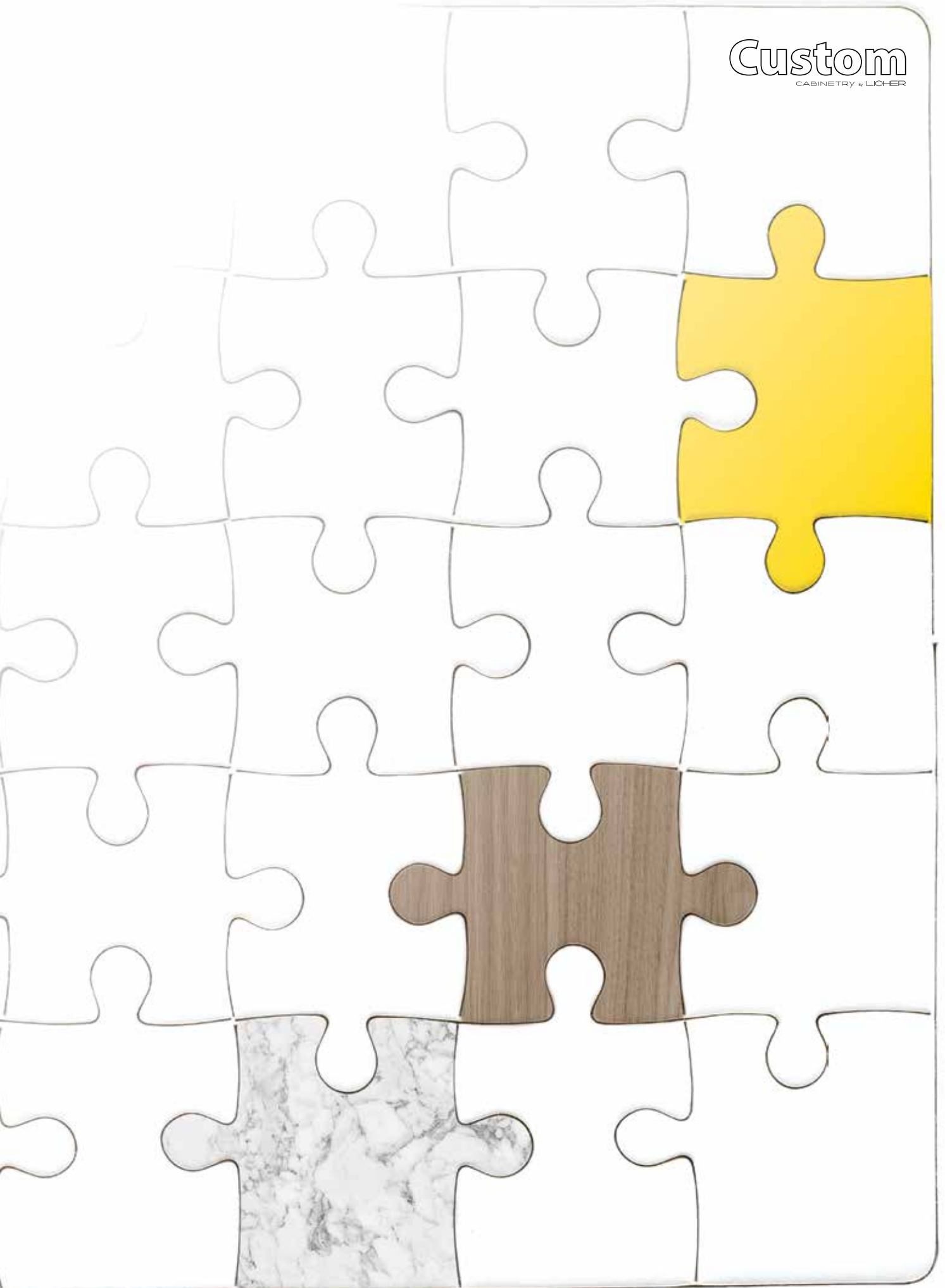

MODULATION

WALL

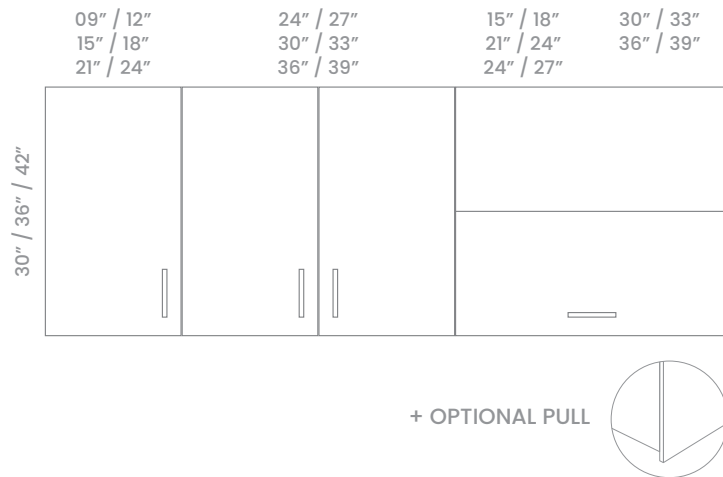

BRIDGES

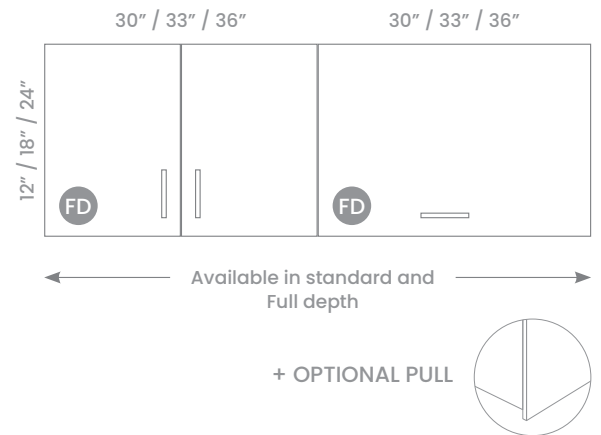

BASE

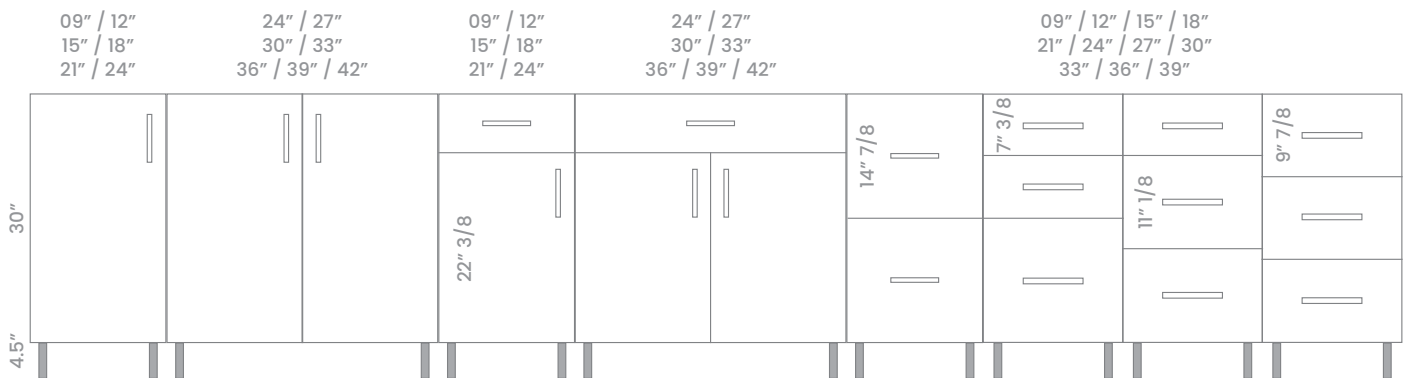

BASE CORNERS

EZ REACH

33 x 33" / 36 x 36"

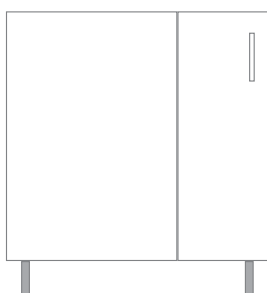

LAZY SUSAN

36 x 36"

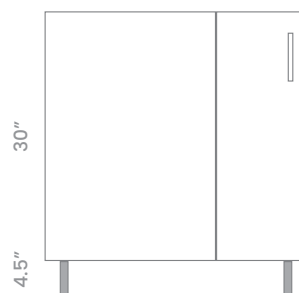

Lazy Susan Hardware included

BASE BLIND

33" / 36" / 39" / 42" / 42" +3 / 42" +6

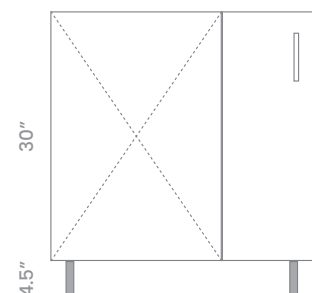

WALL CORNERS

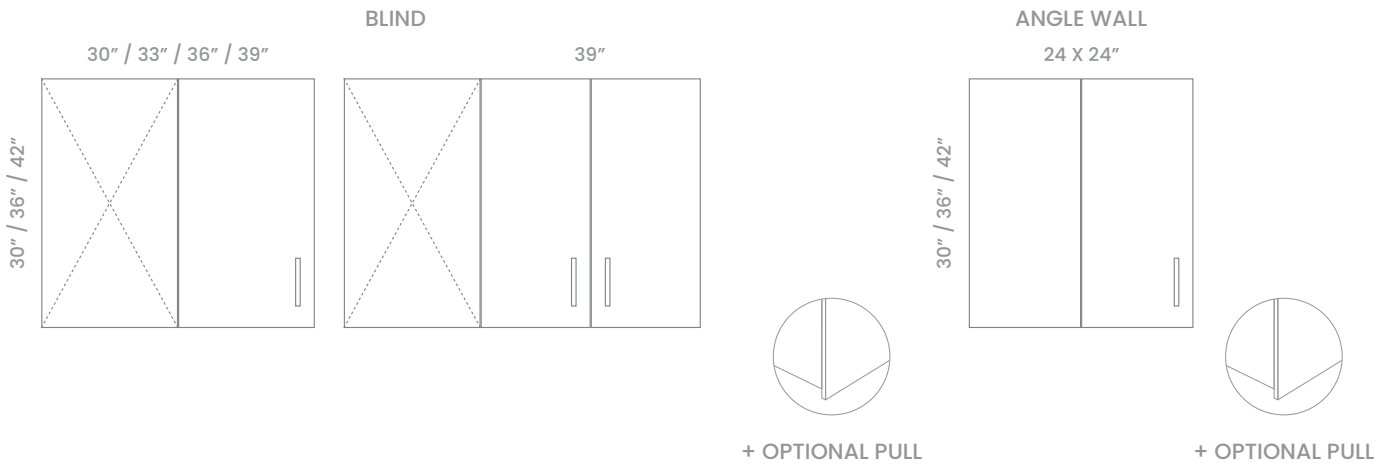

SINK

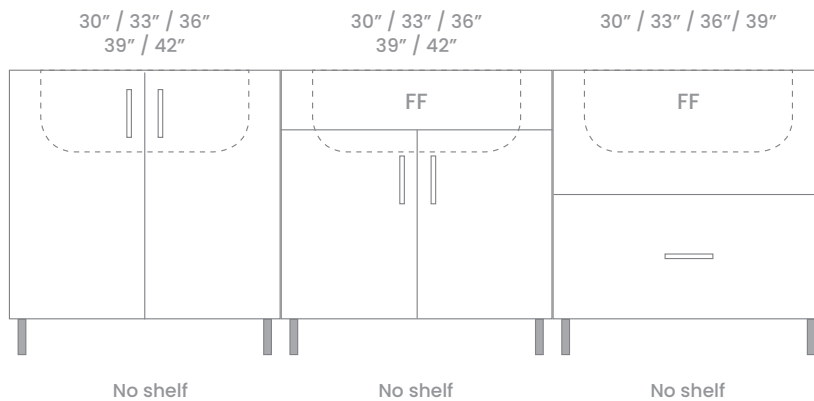

SPECIAL BASES

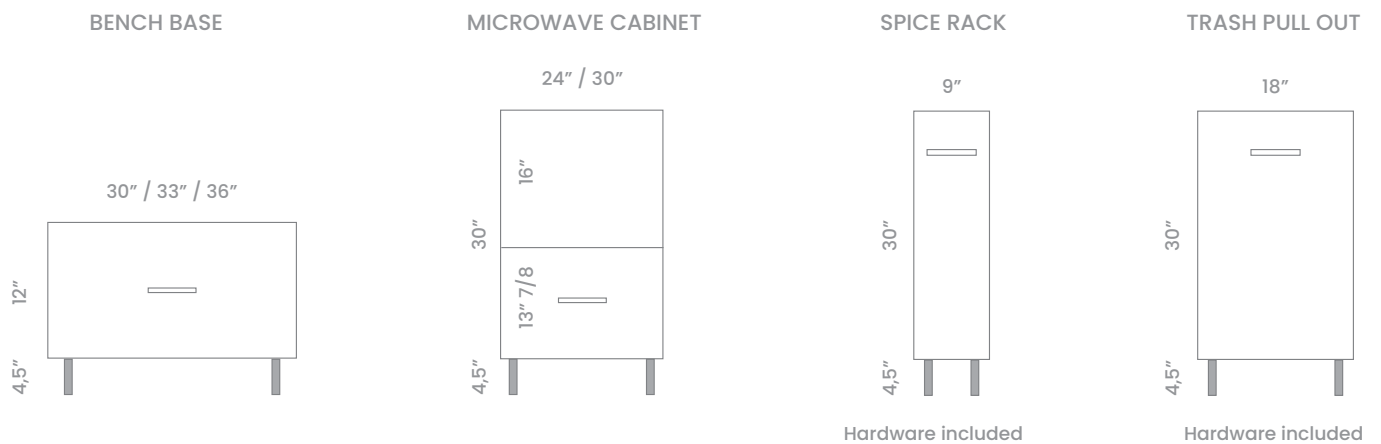

MODULATION

BASE GOLA

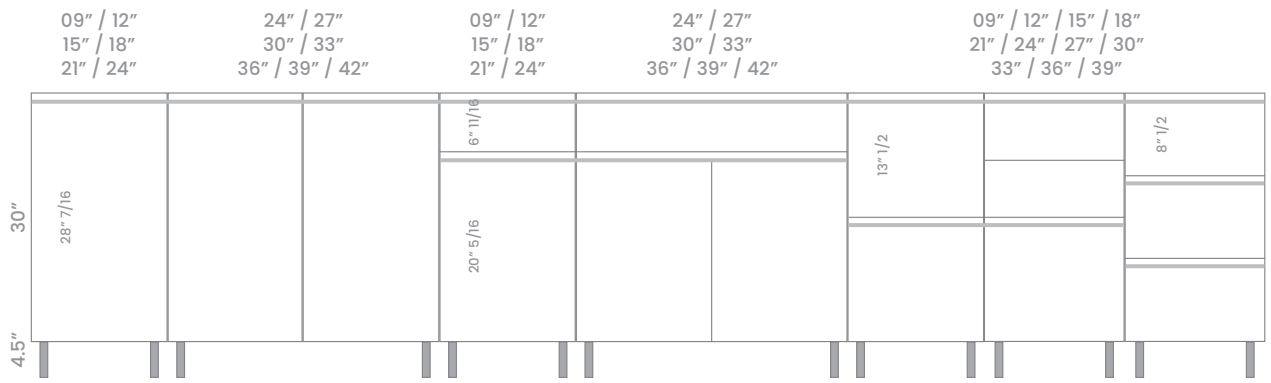

BASE CORNERS GOLA

EZ REACH

33 x 33" / 36 x 36"

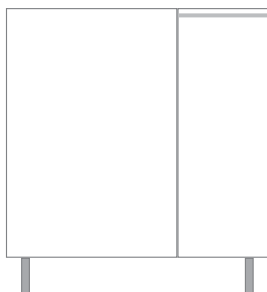

LAZY SUSAN

36 x 36"

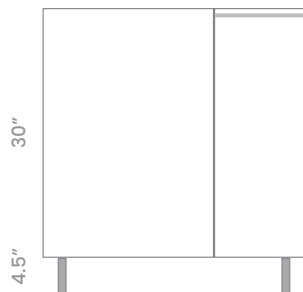

Lazy Susan Hardware included

BASE BLIND

33" / 36" / 39" / 42" / 42" +3 / 42" +6

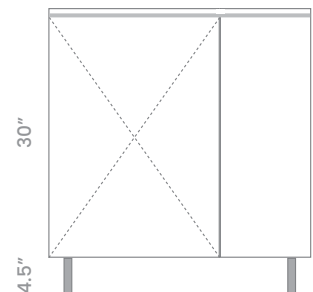

FLOATING VANITIES

*GOLA VANITIES AVAILABLE UPON REQUEST

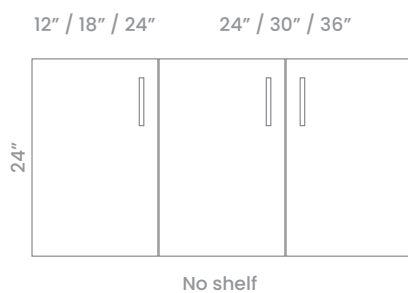

No shelf

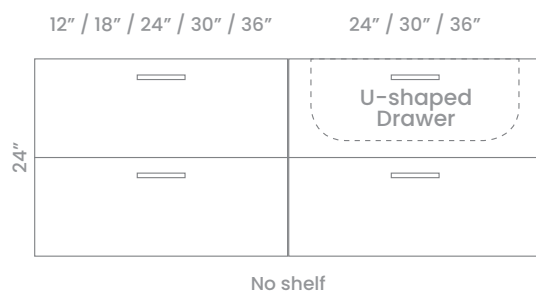

No shelf

SINK GOLA

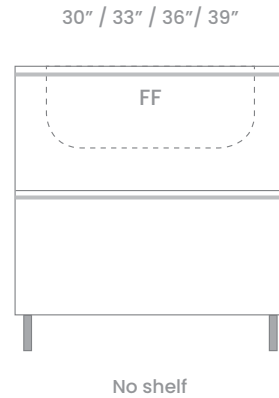
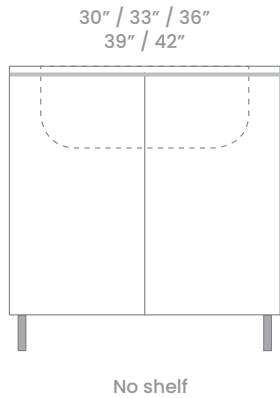

SPECIAL GOLA BASES

BENCH BASE

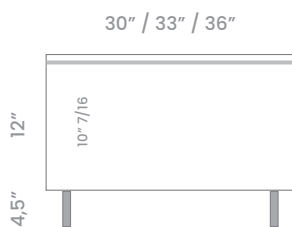

SPICE RACK



Hardware included

TRASH PULL OUT

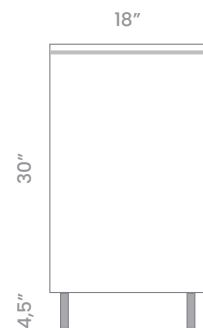

Hardware included

VANITIES

*GOLA VANITIES AVAILABLE UPON REQUEST

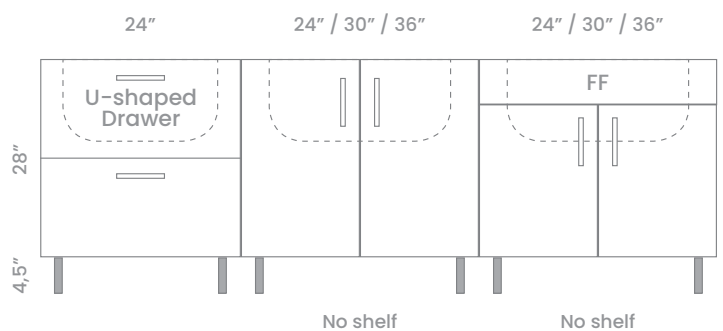
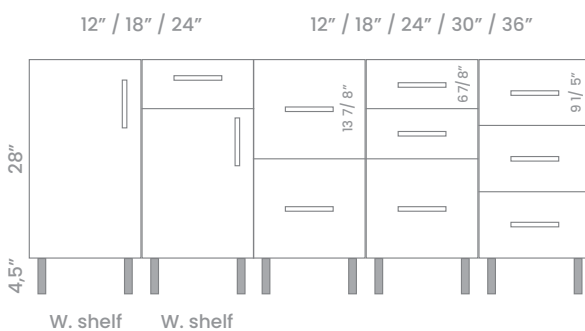

MODULATION

PANTRY

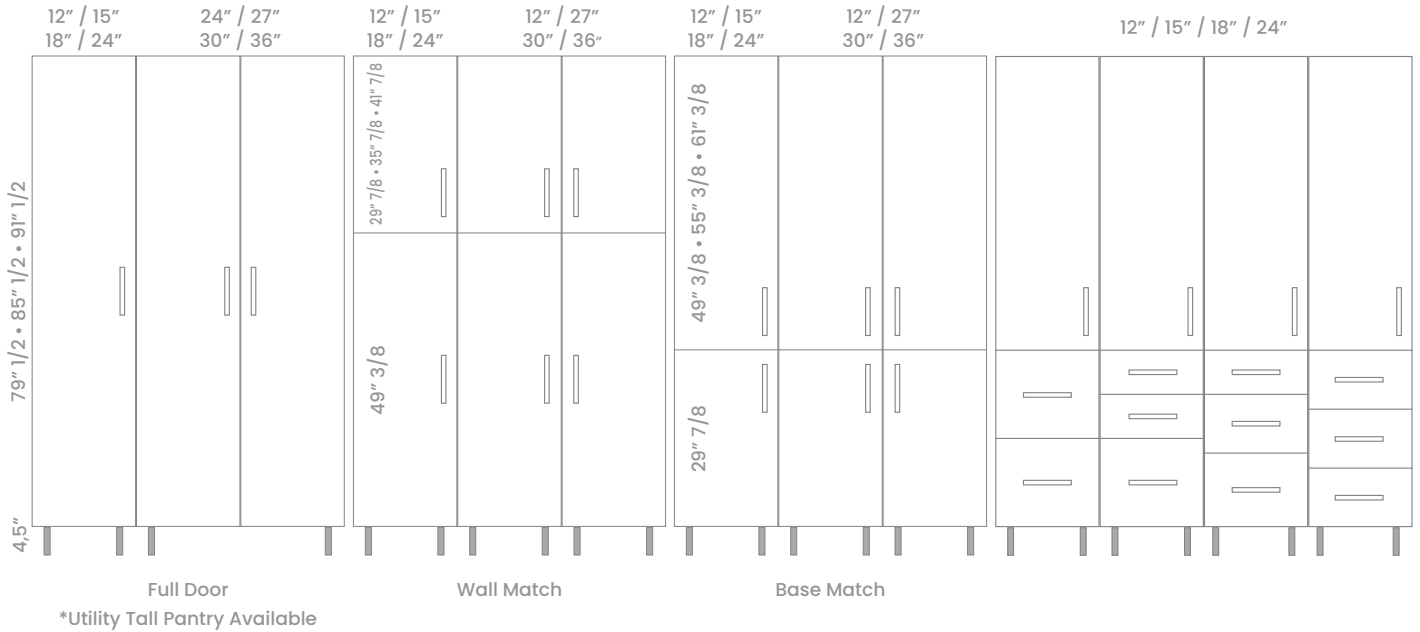

SINGLE OVEN

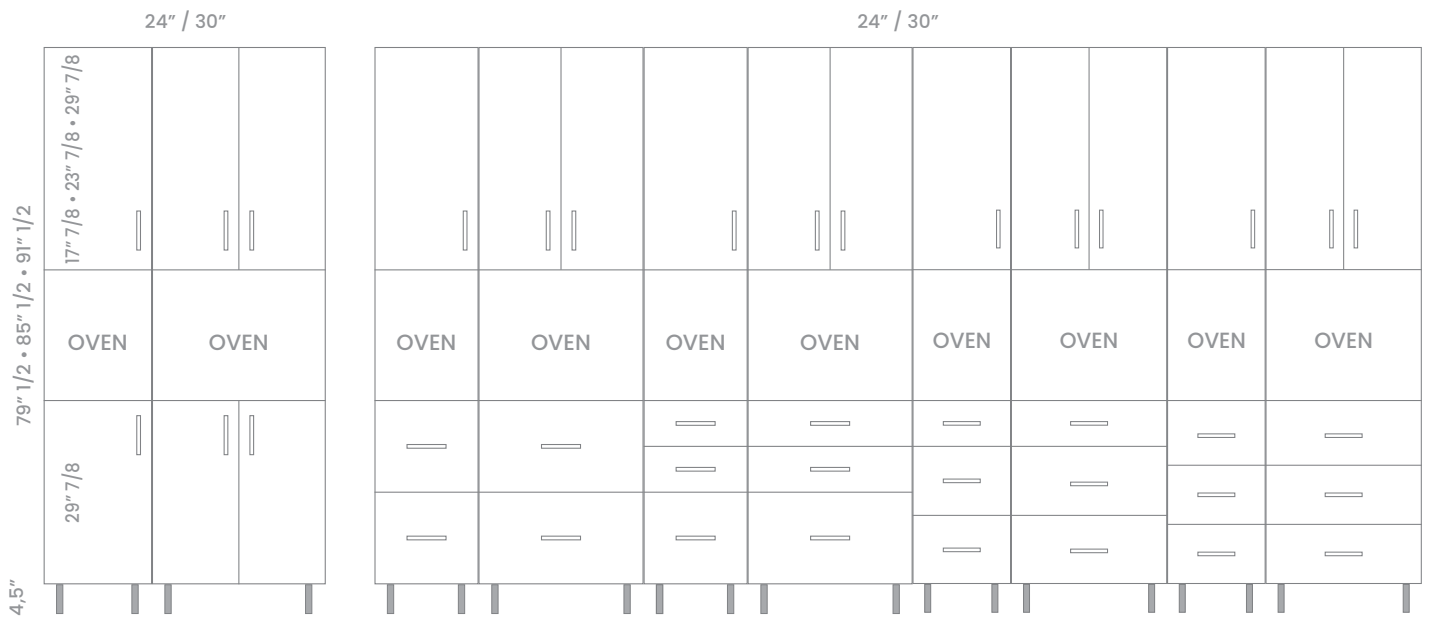

PANTRY

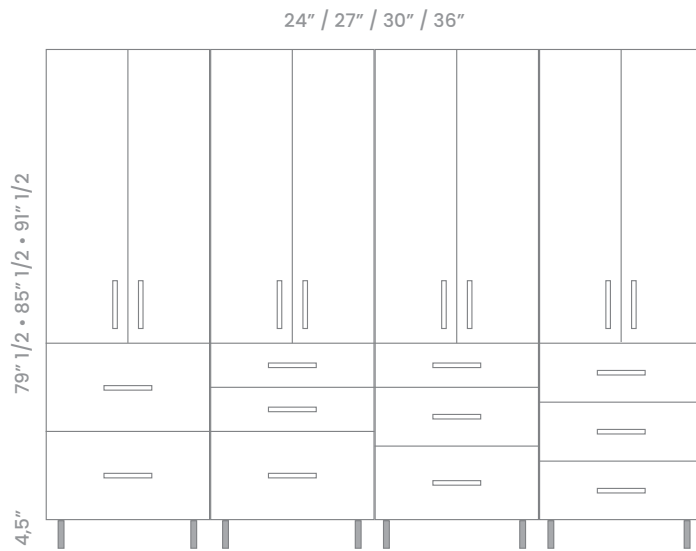

PANTRY GOLA



SINGLE OVEN

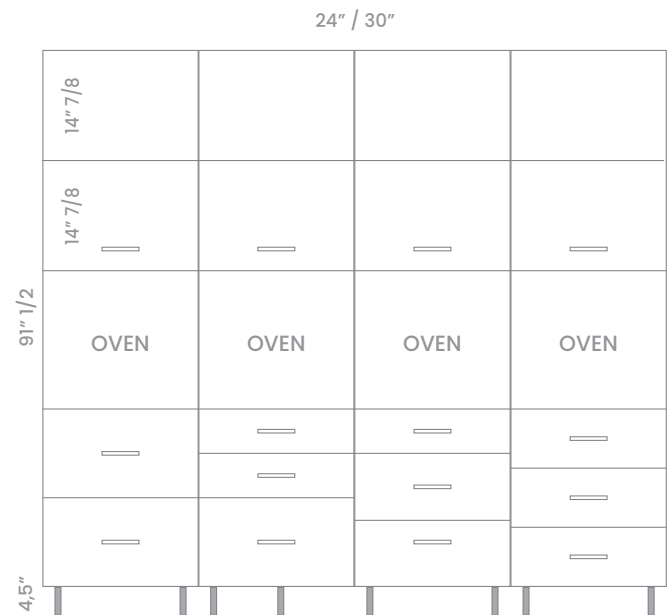
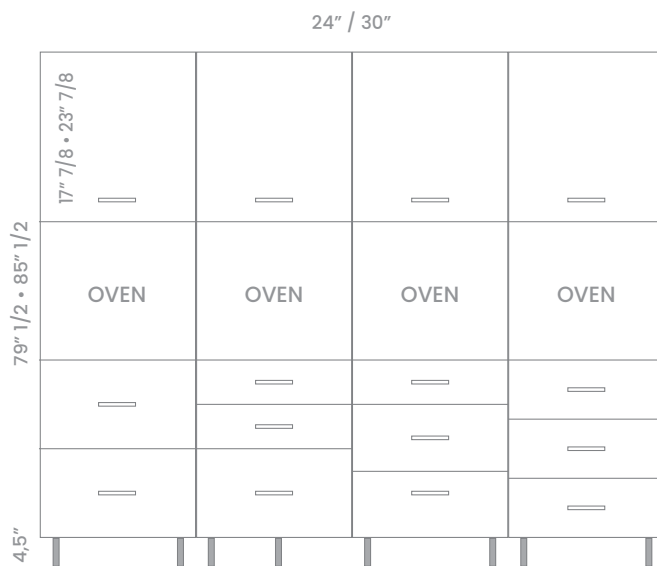

MODULATION

COMBINATION OVEN

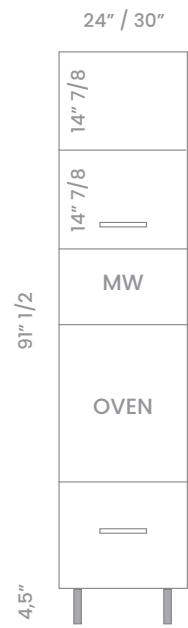
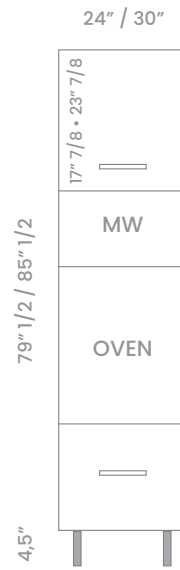
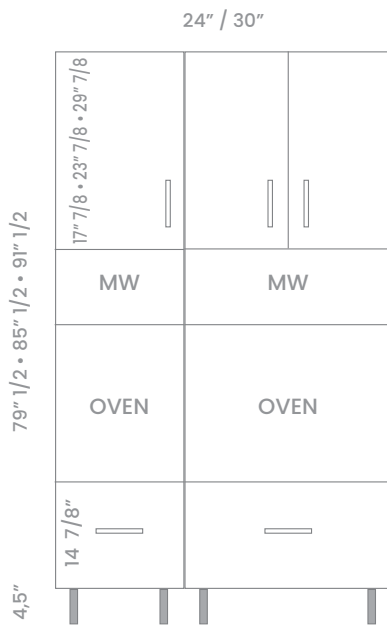

DOUBLE OVEN

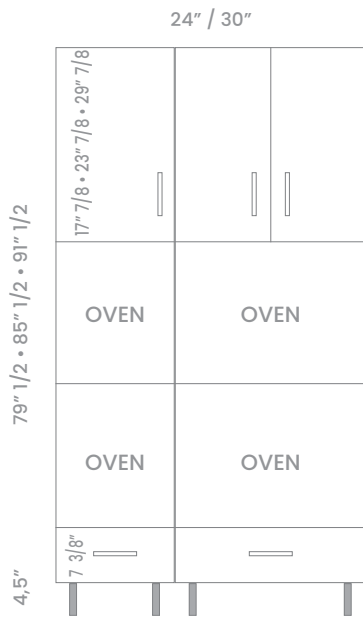

PRICE

LIST



Wall Cabinet - 1 Door

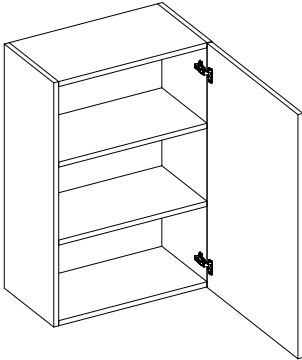

W	H	D	Reference	Cat 1	Cat 2	Cat 3	Cat 4	Cat 5	Cat 6	Cat 7	Cat 8
9	30	13	W930-1DO	148	-	169	180	166	187	171	184
12	30	13	W1230-1DO	166	-	195	209	190	219	197	215
15	30	13	W1530-1DO	184	-	219	237	214	249	222	245
18	30	13	W1830-1DO	202	-	245	266	238	281	248	275
21	30	13	W2130-1DO	223	-	273	298	265	315	277	309
24	30	13	W2430-1DO	241	-	297	326	289	346	302	338
9	36	13	W936-1DO	162	-	188	200	184	209	190	206
12	36	13	W1236-1DO	183	-	217	234	212	246	220	241
15	36	13	W1536-1DO	203	-	245	267	239	282	249	276
18	36	13	W1836-1DO	223	-	274	299	266	317	278	311
21	36	13	W2136-1DO	244	-	304	334	295	355	309	347
24	36	13	W2436-1DO	264	-	333	367	322	391	339	382
9	42	13	W942-1DO	188	-	218	232	213	243	220	239
12	42	13	W1242-1DO	212	-	252	272	246	285	255	280
15	42	13	W1542-1DO	236	-	286	311	279	328	290	322
18	42	13	W1842-1DO	259	-	318	348	309	369	324	361
21	42	13	W2142-1DO	288	-	358	393	347	417	364	408
24	42	13	W2442-1DO	309	-	389	429	377	457	396	446

Notes:

30" and 36" height wall cabinets include 2 adjustable shelves
 42" height wall cabinets include 3 adjustable shelves

Sequence is not available in this configuration

Wall Cabinet - 2 Door

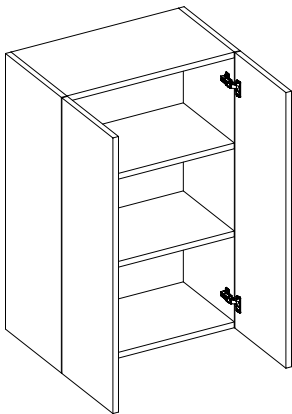

W	H	D	Reference	Cat 1	Cat 2	Cat 3	Cat 4	Cat 5	Cat 6	Cat 7	Cat 8
24	30	13	W2430-2DO	259	-	316	344	307	364	321	357
27	30	13	W2730-2DO	278	-	341	373	332	396	347	387
30	30	13	W3030-2DO	287	-	358	393	347	418	364	409
33	30	13	W3330-2DO	304	-	382	421	371	449	389	438
36	30	13	W3630-2DO	322	-	407	450	394	479	414	468
39	30	13	W3930-2DO	339	-	431	478	417	510	439	498
24	36	13	W2436-2DO	283	-	351	385	341	409	357	400
27	36	13	W2736-2DO	303	-	379	418	368	444	386	434
30	36	13	W3036-2DO	314	-	399	441	386	471	406	460
33	36	13	W3336-2DO	332	-	426	473	412	506	434	493
36	36	13	W3636-2DO	351	-	454	505	438	540	462	527
39	36	13	W3936-2DO	385	-	496	551	479	590	506	576
24	42	13	W2442-2DO	334	-	413	453	401	481	420	470
27	42	13	W2742-2DO	351	-	441	485	427	517	449	505
30	42	13	W3042-2DO	370	-	469	519	454	553	478	540
33	42	13	W3342-2DO	393	-	502	557	486	595	512	581
36	42	13	W3642-2DO	415	-	535	594	516	636	545	620
39	42	13	W3942-2DO	441	-	571	636	551	681	582	664

Notes:

30" and 36" height wall cabinets include 2 adjustable shelves
 42" height wall cabinets include 3 adjustable shelves

Sequence is not available in this configuration

Angle Wall Cabinet – 2 Door

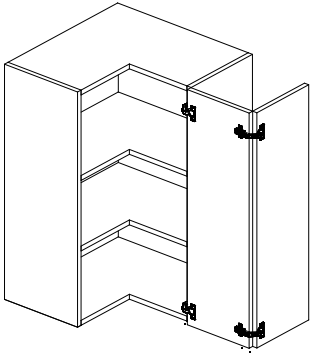

W	H	D	Reference	Cat 1	Cat 2	Cat 3	Cat 4	Cat 5	Cat 6	Cat 7	Cat 8
24	30	13	AW242430-2DO	375	-	423	448	416	464	-	-
24	36	13	AW242436-2DO	400	-	458	487	449	507	-	-
24	42	13	AW242442-2DO	474	-	541	575	531	599	-	-

Sequence is not available in this configuration

Notes:

30" and 36" height wall cabinets include 2 shelves
42" height wall cabinets include 3 adjustable shelves

Angle Wall Cabinet – 2 Door Finger Pull

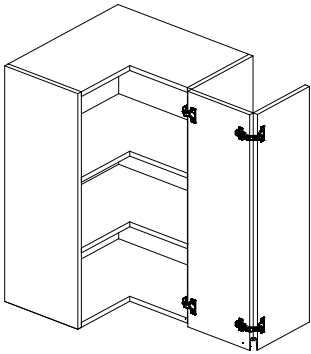

W	H	D	Reference	Cat 1	Cat 2	Cat 3	Cat 4	Cat 5	Cat 6	Cat 7	Cat 8
24	30	13	AW242430-2DOFP	-	-	-	-	-	-	426	457
24	36	13	AW242436-2DOFP	-	-	-	-	-	-	462	498
24	42	13	AW242442-2DOFP	-	-	-	-	-	-	545	588

Notes:

30" and 36" height wall cabinets include 2 shelves
42" height wall cabinets include 3 adjustable shelves

Blind Wall Cabinet - 1 Door

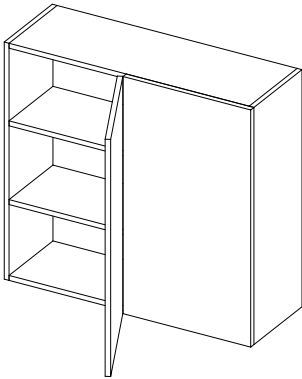

Notes:

30" and 36" height wall cabinets include 2 adjustable shelves
 42" height wall cabinets include 3 adjustable shelves
 Fixed panel is 14" 15/16 wide
 Important: it is strongly recommended to order a filler for the cabinet that connects to the fixed panel

W	H	D	Reference	Cat 1	Cat 2	Cat 3	Cat 4	Cat 5	Cat 6	Cat 7	Cat 8
30	30	13	W3030-24DBL	296	-	372	402	356	427	373	418
33	30	13	W3330-24DBL	313	-	392	430	379	458	398	448
36	30	13	W3630-24DBL	330	-	421	459	403	488	423	477
39	30	13	W3930-24DBL	348	-	446	487	426	519	448	507
30	36	13	W3036-24DBL	322	-	414	450	395	480	415	469
33	36	13	W3336-24DBL	341	-	436	482	421	515	443	503
36	36	13	W3636-24DBL	360	-	469	514	447	550	471	536
39	36	13	W3936-24DBL	394	-	511	560	488	599	515	585
30	42	13	W3042-24DBL	366	-	473	515	450	550	474	537
33	42	13	W3342-24DBL	406	-	523	571	499	609	525	594
36	42	13	W3642-24DBL	428	-	555	608	530	650	558	634
39	42	13	W3942-24DBL	454	-	592	649	565	694	596	677

Sequence is not available in this configuration

Blind Wall Cabinet - 2 Door

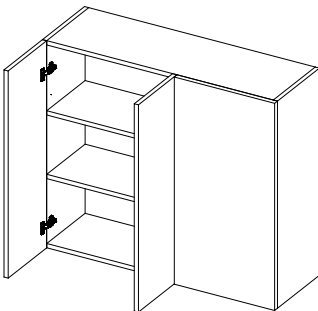

Notes:

30" and 36" height wall cabinets include 2 adjustable shelves
 42" height wall cabinets include 3 adjustable shelves
 Fixed panel is 14" 15/16 wide
 Important: it is strongly recommended to order a filler for the cabinet that connects to the fixed panel.

W	H	D	Reference	Cat 1	Cat 2	Cat 3	Cat 4	Cat 5	Cat 6	Cat 7	Cat 8
39	30	13	W3930-44DBL	367	-	464	505	445	537	467	525
39	36	13	W3936-44DBL	412	-	530	579	506	617	533	603
39	42	13	W3942-44DBL	479	-	616	673	589	718	620	702

Sequence is not available in this configuration

Wall Cabinet - 1 Door Pull

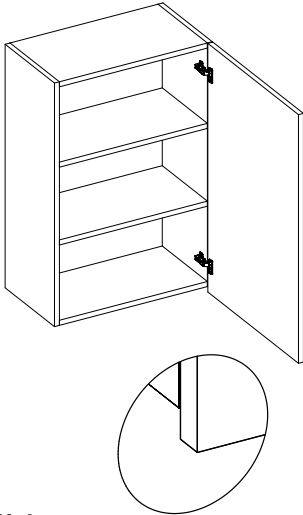

Notes:

30" and 36" height wall cabinets include 2 adjustable shelves

42" height wall cabinets include 3 adjustable shelves

Pull doors are 3/4" longer than the cabinet

W	H	D	Reference	Cat 1	Cat 2	Cat 3	Cat 4	Cat 5	Cat 6	Cat 7	Cat 8
9	30	13	W930-1DOPULL	149	-	170	181	-	-	-	-
12	30	13	W1230-1DOPULL	167	-	196	211	-	-	-	-
15	30	13	W1530-1DOPULL	185	-	221	239	-	-	-	-
18	30	13	W1830-1DOPULL	203	-	246	269	-	-	-	-
21	30	13	W2130-1DOPULL	225	-	275	302	-	-	-	-
24	30	13	W2430-1DOPULL	242	-	300	330	-	-	-	-
9	36	13	W936-1DOPULL	163	-	189	202	-	-	-	-
12	36	13	W1236-1DOPULL	184	-	218	236	-	-	-	-
15	36	13	W1536-1DOPULL	204	-	247	269	-	-	-	-
18	36	13	W1836-1DOPULL	224	-	276	303	-	-	-	-
21	36	13	W2136-1DOPULL	246	-	306	338	-	-	-	-
24	36	13	W2436-1DOPULL	266	-	335	371	-	-	-	-
9	42	13	W942-1DOPULL	188	-	218	234	-	-	-	-
12	42	13	W1242-1DOPULL	213	-	253	274	-	-	-	-
15	42	13	W1542-1DOPULL	237	-	288	314	-	-	-	-
18	42	13	W1842-1DOPULL	260	-	320	351	-	-	-	-
21	42	13	W2142-1DOPULL	289	-	360	396	-	-	-	-
24	42	13	W2442-1DOPULL	311	-	391	433	-	-	-	-

Sequence is not available in this configuration

Wall Cabinet - 2 Door Pull

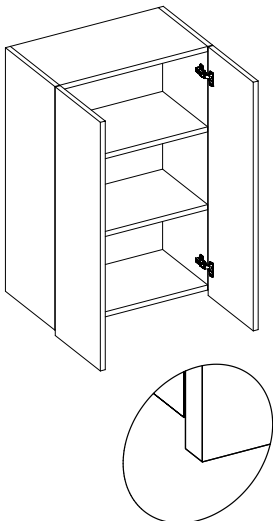

Notes:

30" and 36" height wall cabinets include 2 adjustable shelves

42" height wall cabinets include 3 adjustable shelves

Pull doors are 3/4" longer than the cabinet

W	H	D	Reference	Cat 1	Cat 2	Cat 3	Cat 4	Cat 5	Cat 6	Cat 7	Cat 8
24	30	13	W2430-2DOPULL	261	-	318	349	-	-	-	-
27	30	13	W2730-2DOPULL	280	-	344	378	-	-	-	-
30	30	13	W3030-2DOPULL	289	-	361	399	-	-	-	-
33	30	13	W3330-2DOPULL	307	-	386	427	-	-	-	-
36	30	13	W3630-2DOPULL	324	-	410	456	-	-	-	-
39	30	13	W3930-2DOPULL	342	-	435	484	-	-	-	-
24	36	13	W2436-2DOPULL	285	-	353	389	-	-	-	-
27	36	13	W2736-2DOPULL	305	-	382	422	-	-	-	-
30	36	13	W3036-2DOPULL	316	-	402	447	-	-	-	-
33	36	13	W3336-2DOPULL	335	-	429	479	-	-	-	-
36	36	13	W3636-2DOPULL	354	-	457	511	-	-	-	-
39	36	13	W3936-2DOPULL	388	-	500	558	-	-	-	-
24	42	13	W2442-2DOPULL	336	-	416	457	-	-	-	-
27	42	13	W2742-2DOPULL	353	-	443	490	-	-	-	-
30	42	13	W3042-2DOPULL	372	-	472	524	-	-	-	-
33	42	13	W3342-2DOPULL	395	-	506	563	-	-	-	-
36	42	13	W3642-2DOPULL	418	-	538	601	-	-	-	-
39	42	13	W3942-2DOPULL	444	-	575	643	-	-	-	-

Sequence is not available in this configuration

Angle Wall Cabinet – 2 Door Pull

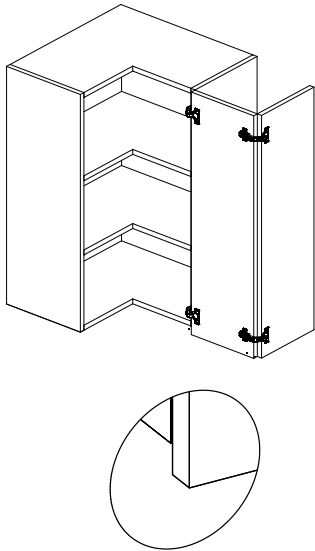

W	H	D	Reference	Cat 1	Cat 2	Cat 3	Cat 4	Cat 5	Cat 6	Cat 7	Cat 8
24	30	13	AW242430-2DOPULL	377	-	426	451	-	-	-	-
24	36	13	AW242436-2DOPULL	402	-	460	491	-	-	-	-
24	42	13	AW242442-2DOPULL	475	-	543	579	-	-	-	-

Sequence is not available in this configuration

Notes:

- 30" and 36" height wall cabinets include 2 adjustable shelves
- 42" height wall cabinets include 3 adjustable shelves
- Pull doors are 3/4" longer than the cabinet

Blind Wall Cabinet – 1 Door Pull

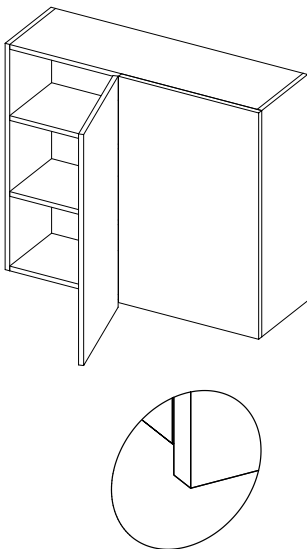

W	H	D	Reference	Cat 1	Cat 2	Cat 3	Cat 4	Cat 5	Cat 6	Cat 7	Cat 8
30	30	13	W3030-24DBLPULL	298	-	370	408	-	-	-	-
33	30	13	W3330-24DBLPULL	315	-	395	436	-	-	-	-
36	30	13	W3630-24DBLPULL	333	-	425	465	-	-	-	-
39	30	13	W3930-24DBLPULL	350	-	449	493	-	-	-	-
30	36	13	W3036-24DBLPULL	332	-	425	464	-	-	-	-
33	36	13	W3336-24DBLPULL	343	-	439	488	-	-	-	-
36	36	13	W3636-24DBLPULL	362	-	472	520	-	-	-	-
39	36	13	W3936-24DBLPULL	405	-	524	576	-	-	-	-
30	42	13	W3042-24DBLPULL	368	-	469	521	-	-	-	-
33	42	13	W3342-24DBLPULL	408	-	520	576	-	-	-	-
36	42	13	W3642-24DBLPULL	431	-	552	614	-	-	-	-
39	42	13	W3942-24DBLPULL	441	-	573	640	-	-	-	-

Sequence is not available in this configuration

Notes:

- Fixed panel is 14" 15/16 wide
- Important: it is strongly recommended to order a filler for the cabinet that connects to the fixed panel.
- 30" and 36" height wall cabinets include 2 adjustable shelves
- 42" height wall cabinets include 3 adjustable shelves
- Pull doors are 3/4" longer than the cabinet

Blind Wall Cabinet – 2 Door Pull

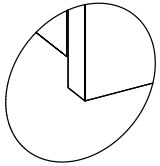
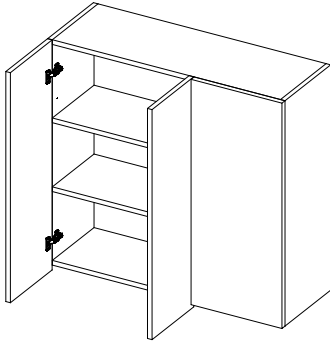

W	H	D	Reference	Cat 1	Cat 2	Cat 3	Cat 4	Cat 5	Cat 6	Cat 7	Cat 8
39	30	13	W3930-44DBLPULL	369	-	463	512	-	-	-	-
39	36	13	W3936-44DBLPULL	415	-	533	586	-	-	-	-
39	42	13	W3942-44DBLPULL	482	-	613	680	-	-	-	-

Sequence is not available in this configuration

Notes:

Fixed panel is 14" 15/16 wide

Important: it is strongly recommended to order a filler for the cabinet that connects to the fixed panel.

30" and 36" height wall cabinets include 2 adjustable shelves

42" height wall cabinets include 3 adjustable shelves

Pull doors are 3/4" longer than the cabinet

Bridge Wall Cabinet – 2 Door

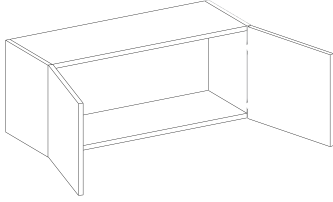

Notes:

Bridge wall cabinets do not include shelves

W	H	D	Reference	Cat 1	Cat 2	Cat 3	Cat 4	Cat 5	Cat 6	Cat 7	Cat 8
30	12	13	MW3012-2DO	162	-	190	205	186	214	193	211
33	12	13	FW3312-2DO	181	-	212	228	207	239	215	235
36	12	13	FW3612-2DO	190	-	224	241	219	253	227	248
30	18	13	MW3018-2DO	194	-	236	258	230	272	240	267
33	18	13	FW3318-2DO	204	-	251	274	244	291	255	284
36	18	13	FW3618-2DO	215	-	266	291	258	309	270	302
30	24	13	MW3024-2DO	217	-	274	302	265	322	279	315
33	24	13	FW3324-2DO	230	-	293	324	283	346	298	337
36	24	13	FW3624-2DO	242	-	310	344	300	368	316	359

Sequence is not available in this configuration

Bridge Wall Cabinet – 2 Door Full Depth

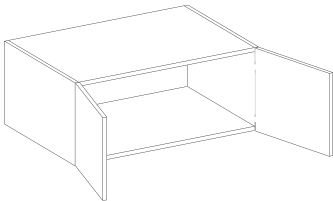

Notes:

Bridge wall cabinets do not include shelves

W	H	D	Reference	Cat 1	Cat 2	Cat 3	Cat 4	Cat 5	Cat 6	Cat 7	Cat 8
30	12	24	MW301224-2DO	162	-	190	205	186	214	193	211
33	12	24	FW331224-2DO	225	-	256	272	251	283	259	279
36	12	24	FW361224-2DO	229	-	263	280	258	292	266	287
30	18	24	MW301824-2DO	215	-	257	278	251	293	261	287
33	18	24	FW331824-2DO	252	-	299	322	292	339	303	332
36	18	24	FW361824-2DO	258	-	309	334	301	352	313	345
30	24	24	MW302424-2DO	238	-	295	323	286	343	300	335
33	24	24	FW332424-2DO	279	-	342	373	332	395	347	386
36	24	24	FW362424-2DO	287	-	355	389	345	413	361	404

Sequence is not available in this configuration

Bridge Wall Cabinet – 2 Door Pull

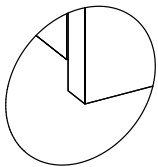
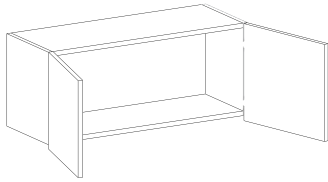

W	H	D	Reference	Cat 1	Cat 2	Cat 3	Cat 4	Cat 5	Cat 6	Cat 7	Cat 8
30	12	13	MW3012-2DOPULL	164	-	193	210	-	-	-	-
33	12	13	FW3312-2DOPULL	184	-	217	234	-	-	-	-
36	12	13	FW3612-2DOPULL	193	-	228	247	-	-	-	-
30	18	13	MW3018-2DOPULL	196	-	239	263	-	-	-	-
33	18	13	FW3318-2DOPULL	207	-	256	280	-	-	-	-
36	18	13	FW3618-2DOPULL	217	-	269	297	-	-	-	-
30	24	13	MW3024-2DOPULL	220	-	277	308	-	-	-	-
33	24	13	FW3324-2DOPULL	233	-	297	330	-	-	-	-
36	24	13	FW3624-2DOPULL	245	-	314	351	-	-	-	-

Sequence is not available in this configuration

Notes:

Pull doors are 3/4" longer than the cabinet

Bridge wall cabinets do not include shelves

Bridge Wall Cabinet – 2 Door Pull Full Depth

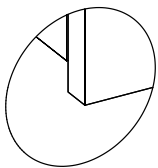
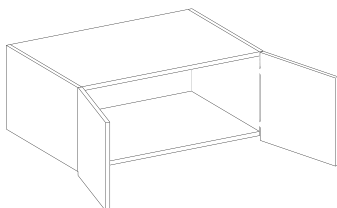

W	H	D	Reference	Cat 1	Cat 2	Cat 3	Cat 4	Cat 5	Cat 6	Cat 7	Cat 8
30	12	24	MW301224-2DOPULL	164	-	195	210	-	-	-	-
33	12	24	FW331224-2DOPULL	228	-	261	278	-	-	-	-
36	12	24	FW361224-2DOPULL	232	-	267	286	-	-	-	-
30	18	24	MW301824-2DOPULL	217	-	260	283	-	-	-	-
33	18	24	FW331824-2DOPULL	255	-	304	328	-	-	-	-
36	18	24	FW361824-2DOPULL	260	-	312	340	-	-	-	-
30	24	24	MW302424-2DOPULL	240	-	298	328	-	-	-	-
33	24	24	FW332424-2DOPULL	282	-	346	379	-	-	-	-
36	24	24	FW362424-2DOPULL	290	-	359	396	-	-	-	-

Sequence is not available in this configuration

Notes:

Pull doors are 3/4" longer than the cabinet

Bridge wall cabinets do not include shelves

Bridge Wall Cabinet – 1 Flip Up Door

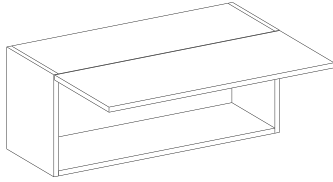

Notes:

Bridge wall cabinets do not include shelves

W	H	D	Reference	Cat 1	Cat 2	Cat 3	Cat 4	Cat 5	Cat 6	Cat 7	Cat 8
30	12	13	MW3012-FT	277	-	305	319	301	329	308	326
33	12	13	FW3312-FT	296	-	327	343	322	353	330	349
36	12	13	FW3612-FT	305	-	339	356	334	368	342	363
30	18	13	MW3018-FT	309	-	352	373	345	388	355	382
33	18	13	FW3318-FT	319	-	366	390	359	406	370	400
36	18	13	FW3618-FT	330	-	381	406	373	424	385	418
30	24	13	MW3024-FT	333	-	390	418	381	438	394	430
33	24	13	FW3324-FT	336	-	399	430	389	452	404	444
36	24	13	FW3624-FT	348	-	416	451	406	474	422	465

Sequence is not available in this configuration

Bridge Wall Cabinet – 1 Flip Up Door Full Depth

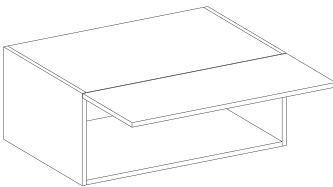

Notes:

Bridge wall cabinets do not include shelves

W	H	D	Reference	Cat 1	Cat 2	Cat 3	Cat 4	Cat 5	Cat 6	Cat 7	Cat 8
30	12	24	MW301224-FT	277	-	305	319	301	329	308	326
33	12	24	FW331224-FT	340	-	371	387	366	397	374	393
36	12	24	FW361224-FT	344	-	378	395	373	407	381	402
30	18	24	MW301824-FT	309	-	352	373	345	388	355	382
33	18	24	FW331824-FT	367	-	414	438	407	454	418	448
36	18	24	FW361824-FT	373	-	424	449	416	467	428	461
30	24	24	MW302424-FT	333	-	390	418	381	438	394	430
33	24	24	FW332424-FT	385	-	448	479	438	501	453	493
36	24	24	FW362424-FT	393	-	461	496	451	519	467	510

Sequence is not available in this configuration

Bridge Wall Cabinet – 1 Flip Up Door Pull

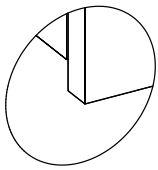
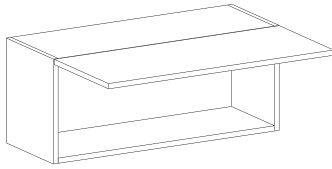

W	H	D	Reference	Cat 1	Cat 2	Cat 3	Cat 4	Cat 5	Cat 6	Cat 7	Cat 8
30	12	13	MW3012-FTPULL	279	-	308	325	-	-	-	-
33	12	13	FW3312-FTPULL	298	-	332	348	-	-	-	-
36	12	13	FW3612-FTPULL	307	-	339	362	-	-	-	-
30	18	13	MW3018-FTPULL	311	-	354	378	-	-	-	-
33	18	13	FW3318-FTPULL	322	-	371	395	-	-	-	-
36	18	13	FW3618-FTPULL	332	-	385	413	-	-	-	-
30	24	13	MW3024-FTPULL	335	-	393	423	-	-	-	-
33	24	13	FW3324-FTPULL	338	-	403	436	-	-	-	-
36	24	13	FW3624-FTPULL	350	-	420	457	-	-	-	-

Sequence is not available in this configuration

Notes:

Pull doors are 3/4" longer than the cabinet

Bridge wall cabinets do not include shelves

Bridge Wall Cabinet – 1 Flip Up Door Pull Full Depth

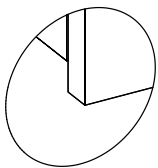
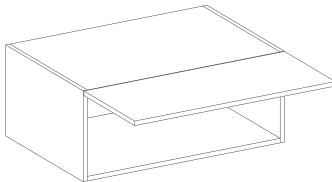

W	H	D	Reference	Cat 1	Cat 2	Cat 3	Cat 4	Cat 5	Cat 6	Cat 7	Cat 8
30	12	24	MW301224-FTPULL	279	-	309	325	-	-	-	-
33	12	24	FW331224-FTPULL	342	-	376	392	-	-	-	-
36	12	24	FW361224-FTPULL	346	-	378	401	-	-	-	-
30	18	24	MW301824-FTPULL	311	-	355	378	-	-	-	-
33	18	24	FW331824-FTPULL	370	-	419	443	-	-	-	-
36	18	24	FW361824-FTPULL	375	-	428	456	-	-	-	-
30	24	24	MW302424-FTPULL	335	-	393	423	-	-	-	-
33	24	24	FW332424-FTPULL	387	-	452	485	-	-	-	-
36	24	24	FW362424-FTPULL	395	-	465	502	-	-	-	-

Sequence is not available in this configuration

Notes:

Pull doors are 3/4" longer than the cabinet

Bridge wall cabinets do not include shelves

Wall Cabinet - 2 Flip Up Door

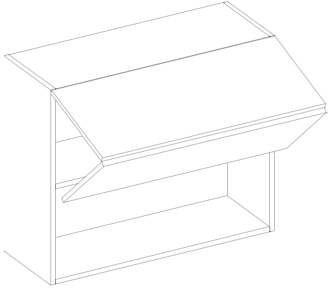

W	H	D	Reference	Cat 1	Cat 2	Cat 3	Cat 4	Cat 5	Cat 6	Cat 7	Cat 8
15	30	13	W1530-2FT	705	716	740	758	735	770	744	766
18	30	13	W1830-2FT	723	736	766	787	759	802	770	796
21	30	13	W2130-2FT	745	760	794	819	787	836	799	830
24	30	13	W2430-2FT	762	779	819	847	810	867	824	859
27	30	13	W2730-2FT	814	833	878	910	868	932	883	924
30	30	13	W3030-2FT	823	845	894	930	883	954	900	945
33	30	13	W3330-2FT	841	864	919	958	907	985	926	975
36	30	13	W3630-2FT	858	884	943	986	930	1015	951	1004
39	30	13	W3930-2FT	875	903	968	1014	953	1046	976	1034
15	36	13	W1536-2FT	754	767	797	818	790	833	800	827
18	36	13	W1836-2FT	808	823	859	884	851	902	863	895
21	36	13	W2136-2FT	829	848	889	919	880	940	894	932
24	36	13	W2436-2FT	849	870	917	951	907	975	923	966
27	36	13	W2736-2FT	869	892	946	984	934	1011	952	1001
30	36	13	W3036-2FT	880	906	965	1008	952	1037	972	1026
33	36	13	W3336-2FT	922	951	1016	1063	1002	1096	1024	1084
36	36	13	W3636-2FT	1021	1052	1123	1175	1108	1210	1132	1197
39	36	13	W3936-2FT	1055	1089	1166	1221	1149	1260	1175	1245
15	42	13	W1542-2FT	815	830	865	890	857	907	869	900
18	42	13	W1842-2FT	837	856	897	927	888	948	902	940
21	42	13	W2142-2FT	867	888	936	971	926	995	942	986
24	42	13	W2442-2FT	912	936	991	1031	979	1059	998	1049
27	42	13	W2742-2FT	929	956	1019	1063	1005	1095	1026	1083
30	42	13	W3042-2FT	947	978	1047	1097	1032	1131	1056	1118
33	42	13	W3342-2FT	1050	1084	1160	1215	1143	1253	1170	1239
36	42	13	W3642-2FT	1073	1109	1192	1252	1174	1294	1203	1278
39	42	13	W3942-2FT	1577	1617	1707	1772	1687	1817	1718	1800

Wall Cabinet - 2 Flip Up Door Pull

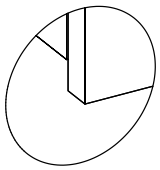
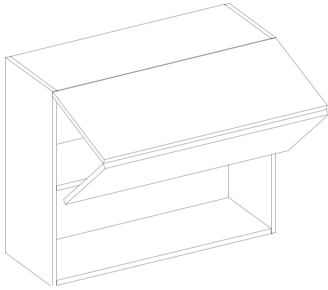

W	H	D	Reference	Cat 1	Cat 2	Cat 3	Cat 4	Cat 5	Cat 6	Cat 7	Cat 8
15	30	13	W1530-2FTPULL	706	717	742	760	-	-	-	-
18	30	13	W1830-2FTPULL	725	738	767	790	-	-	-	-
21	30	13	W2130-2FTPULL	746	761	796	822	-	-	-	-
24	30	13	W2430-2FTPULL	763	781	821	851	-	-	-	-
27	30	13	W2730-2FTPULL	816	836	880	914	-	-	-	-
30	30	13	W3030-2FTPULL	825	847	897	934	-	-	-	-
33	30	13	W3330-2FTPULL	843	867	921	963	-	-	-	-
36	30	13	W3630-2FTPULL	826	853	912	957	-	-	-	-
39	30	13	W3930-2FTPULL	878	906	971	1020	-	-	-	-
15	36	13	W1536-2FTPULL	755	768	798	820	-	-	-	-
18	36	13	W1836-2FTPULL	809	825	860	887	-	-	-	-
21	36	13	W2136-2FTPULL	831	849	891	922	-	-	-	-
24	36	13	W2436-2FTPULL	851	872	919	955	-	-	-	-
27	36	13	W2736-2FTPULL	871	894	948	988	-	-	-	-
30	36	13	W3036-2FTPULL	905	932	991	1036	-	-	-	-
33	36	13	W3336-2FTPULL	924	954	1019	1068	-	-	-	-
36	36	13	W3636-2FTPULL	1023	1055	1126	1180	-	-	-	-
39	36	13	W3936-2FTPULL	977	1012	1089	1147	-	-	-	-
15	42	13	W1542-2FTPULL	816	831	866	892	-	-	-	-
18	42	13	W1842-2FTPULL	838	857	898	929	-	-	-	-
21	42	13	W2142-2FTPULL	830	851	900	936	-	-	-	-
24	42	13	W2442-2FTPULL	913	938	993	1035	-	-	-	-
27	42	13	W2742-2FTPULL	931	958	1021	1068	-	-	-	-
30	42	13	W3042-2FTPULL	949	980	1049	1101	-	-	-	-
33	42	13	W3342-2FTPULL	1052	1086	1163	1220	-	-	-	-
36	42	13	W3642-2FTPULL	1075	1112	1195	1257	-	-	-	-
39	42	13	W3942-2FTPULL	1580	1620	1710	1778	-	-	-	-

Base Cabinet - 1 Door

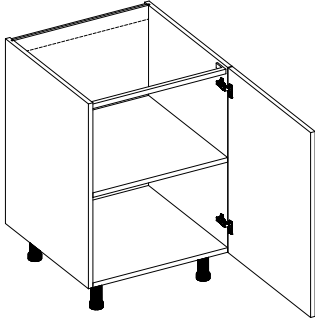

W	H	D	Reference	Cat 1	Cat 2	Cat 3	Cat 4	Cat 5	Cat 6	Cat 7	Cat 8
9	30	24	B9-1DO	188	-	209	219	206	227	211	224
12	30	24	B12-1DO	193	-	221	235	217	245	223	241
15	30	24	B15-1DO	210	-	245	263	240	276	249	271
18	30	24	B18-1DO	219	-	262	283	255	298	266	293
21	30	24	B21-1DO	238	-	287	312	280	330	292	323
24	30	24	B24-1DO	254	-	311	339	302	359	316	352

Sequence is not available in this configuration

Base Cabinet - 2 Door

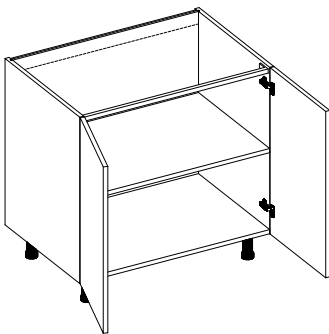

W	H	D	Reference	Cat 1	Cat 2	Cat 3	Cat 4	Cat 5	Cat 6	Cat 7	Cat 8
24	30	24	B24-2DO	273	-	329	358	321	377	334	370
27	30	24	B27-2DO	289	-	353	385	343	407	358	399
30	30	24	B30-2DO	305	-	376	412	366	437	383	427
33	30	24	B33-2DO	322	-	400	439	388	466	407	456
36	30	24	B36-2DO	343	-	428	471	415	501	436	489
39	30	24	B39-2DO	360	-	453	499	439	531	461	519
42	30	24	B42-2DO	400	-	500	550	485	584	509	571

Sequence is not available in this configuration

Base Cabinet - 1 Door Reduced Depth

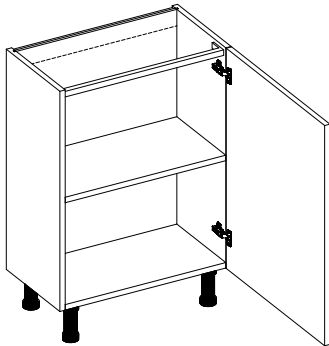

W	H	D	Reference	Cat 1	Cat 2	Cat 3	Cat 4	Cat 5	Cat 6	Cat 7	Cat 8
9	30	13	BRD9-1DO	150	-	172	182	168	189	173	187
12	30	13	BRD12-1DO	169	-	197	211	193	221	199	217
15	30	13	BRD15-1DO	186	-	221	239	216	252	225	247
18	30	13	BRD18-1DO	204	-	247	268	240	283	251	278
21	30	13	BRD21-1DO	226	-	275	300	268	318	280	311
24	30	13	BRD24-1DO	243	-	300	328	291	348	305	341

Sequence is not available in this configuration

Base Cabinet - 2 Door Reduced Depth

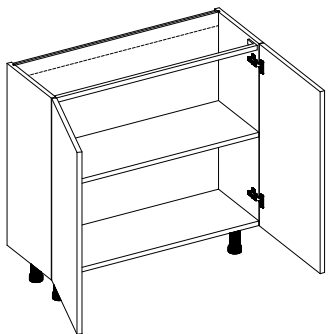

W	H	D	Reference	Cat 1	Cat 2	Cat 3	Cat 4	Cat 5	Cat 6	Cat 7	Cat 8
24	30	13	BRD24-2DO	262	-	318	347	310	366	323	359
27	30	13	BRD27-2DO	280	-	344	376	334	398	349	390
30	30	13	BRD30-2DO	289	-	360	396	350	421	367	411
33	30	13	BRD33-2DO	307	-	385	424	373	451	392	441
36	30	13	BRD36-2DO	324	-	409	452	396	482	417	470
39	30	13	BRD39-2DO	341	-	434	480	420	512	442	500

Sequence is not available in this configuration

Base Cabinet - 1 Door Spice Rack

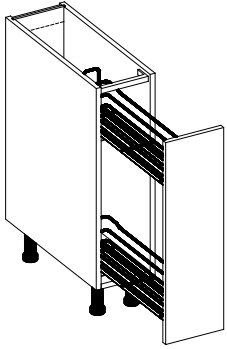

W	H	D	Reference	Cat 1	Cat 2	Cat 3	Cat 4	Cat 5	Cat 6	Cat 7	Cat 8
9	30	24	B9-LDR	300	-	322	332	318	340	323	337

Sequence is not available in this configuration

Notes:

Hardware Included

Base Cabinet - 1 Door Trash Pull Out

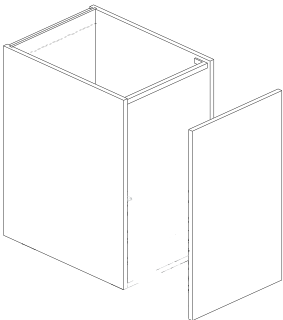

W	H	D	Reference	Cat 1	Cat 2	Cat 3	Cat 4	Cat 5	Cat 6	Cat 7	Cat 8
18	30	24	B18-LDR	526	-	569	590	562	605	572	599

Sequence is not available in this configuration

Notes:

Hardware Included

Base Cabinet - 1 Door 1 Drawer

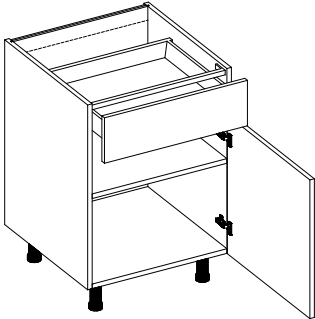

W	H	D	Reference	Cat 1	Cat 2	Cat 3	Cat 4	Cat 5	Cat 6	Cat 7	Cat 8
9	30	24	B9-1DO1DR	245	253	272	286	268	295	274	292
12	30	24	B12-1DO1DR	260	270	293	309	288	320	296	316
15	30	24	B15-1DO1DR	277	289	315	334	310	348	319	343
18	30	24	B18-1DO1DR	287	300	330	352	323	367	334	361
21	30	24	B21-1DO1DR	306	321	355	380	348	397	360	391
24	30	24	B24-1DO1DR	324	341	381	409	372	429	386	421

Base Cabinet - 2 Door 1 Drawer

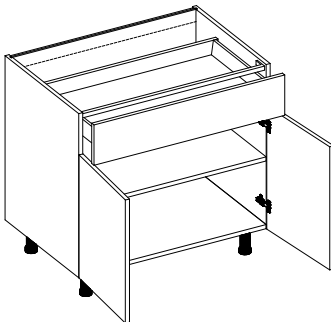

W	H	D	Reference	Cat 1	Cat 2	Cat 3	Cat 4	Cat 5	Cat 6	Cat 7	Cat 8
24	30	24	B24-2DO1DR	343	360	399	428	391	447	404	440
27	30	24	B27-2DO1DR	361	380	425	456	415	479	430	470
30	30	24	B30-2DO1DR	379	401	450	485	439	510	456	501
33	30	24	B33-2DO1DR	397	421	475	514	463	541	482	531
36	30	24	B36-2DO1DR	420	446	505	548	493	578	513	566
39	30	24	B39-2DO1DR	440	468	532	578	518	610	540	598
42	30	24	B42-2DO1DR	462	492	561	611	546	645	570	632

Notes:

Includes a rail between drawer front and doors

Base Cabinet - 2 Drawer

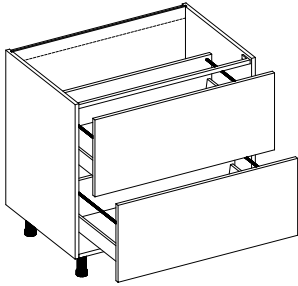

W	H	D	Reference	Cat 1	Cat 2	Cat 3	Cat 4	Cat 5	Cat 6	Cat 7	Cat 8
9	30	24	B9-2DR	295	302	318	329	314	337	320	334
12	30	24	B12-2DR	299	307	327	341	322	351	329	347
15	30	24	B15-2DR	314	325	350	367	344	380	353	375
18	30	24	B18-2DR	335	348	377	399	371	413	381	408
21	30	24	B21-2DR	354	369	403	428	396	445	407	439
24	30	24	B24-2DR	372	389	429	457	420	477	434	470
27	30	24	B27-2DR	390	409	454	486	444	508	459	500
30	30	24	B30-2DR	410	431	481	516	470	541	487	531
33	30	24	B33-2DR	430	454	508	547	496	575	515	564
36	30	24	B36-2DR	446	472	531	574	518	603	539	592
39	30	24	B39-2DR	463	491	555	601	541	633	563	621

Base Cabinet - 1 Bottom 2 Top Drawer

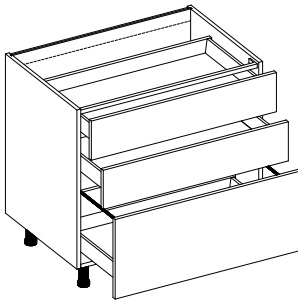

W	H	D	Reference	Cat 1	Cat 2	Cat 3	Cat 4	Cat 5	Cat 6	Cat 7	Cat 8
9	30	24	B9-12DR	363	373	397	414	392	426	400	422
12	30	24	B12-12DR	364	375	401	419	395	432	404	427
15	30	24	B15-12DR	377	390	418	438	412	452	422	447
18	30	24	B18-12DR	396	409	440	462	433	478	444	472
21	30	24	B21-12DR	414	429	463	488	456	505	468	499
24	30	24	B24-12DR	434	451	491	519	482	539	496	531
27	30	24	B27-12DR	453	473	517	549	507	571	523	563
30	30	24	B30-12DR	475	496	545	581	534	605	551	596
33	30	24	B33-12DR	507	531	585	624	573	651	592	641
36	30	24	B36-12DR	514	540	599	641	586	671	606	660
39	30	24	B39-12DR	532	560	624	670	610	702	632	690

Base Cabinet - 2 Bottom 1 Top Drawer

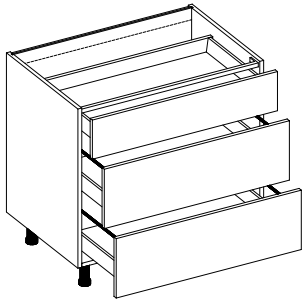

W	H	D	Reference	Cat 1	Cat 2	Cat 3	Cat 4	Cat 5	Cat 6	Cat 7	Cat 8
9	30	24	B9-21DR	368	378	402	419	397	431	405	427
12	30	24	B12-21DR	368	378	402	420	397	432	405	427
15	30	24	B15-21DR	382	393	420	439	414	452	423	447
18	30	24	B18-21DR	402	415	446	467	439	482	449	477
21	30	24	B21-21DR	422	437	471	496	464	513	475	507
24	30	24	B24-21DR	442	459	499	527	490	547	504	539
27	30	24	B27-21DR	462	481	525	557	516	579	531	571
30	30	24	B30-21DR	483	505	554	589	543	614	560	605
33	30	24	B33-21DR	506	529	584	622	572	649	590	639
36	30	24	B36-21DR	523	549	608	651	595	680	615	669
39	30	24	B39-21DR	542	570	634	680	620	712	642	700

Base Cabinet - 3 Drawer

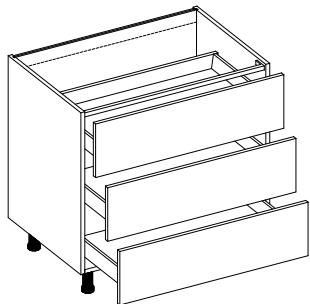

W	H	D	Reference	Cat 1	Cat 2	Cat 3	Cat 4	Cat 5	Cat 6	Cat 7	Cat 8
9	30	24	B9-3DR	365	375	399	416	394	428	402	424
12	30	24	B12-3DR	354	365	389	406	384	418	392	414
15	30	24	B15-3DR	365	375	400	417	395	430	403	425
18	30	24	B18-3DR	387	399	429	450	422	465	432	459
21	30	24	B21-3DR	406	421	456	480	448	498	460	491
24	30	24	B24-3DR	426	443	483	511	474	531	488	523
27	30	24	B27-3DR	445	464	509	540	499	563	514	554
30	30	24	B30-3DR	466	487	537	572	526	596	543	587
33	30	24	B33-3DR	488	511	565	604	554	631	572	621
36	30	24	B36-3DR	505	530	589	632	577	661	597	650
39	30	24	B39-3DR	522	550	614	660	600	692	622	680

Microwave Base Cabinet- 1 Drawer

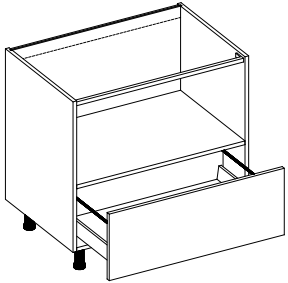

W	H	D	Reference	Cat 1	Cat 2	Cat 3	Cat 4	Cat 5	Cat 6	Cat 7	Cat 8
24	30	24	MB24-1DR	263	-	289	303	285	312	292	308
30	30	24	MB30-1DR	288	-	321	338	316	349	324	345

Sequence is not available in this configuration

Bench Base Cabinet - 1 Drawer

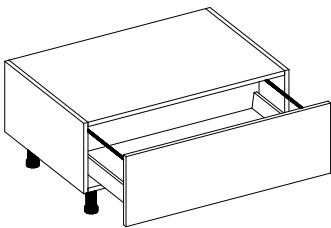

W	H	D	Reference	Cat 1	Cat 2	Cat 3	Cat 4	Cat 5	Cat 6	Cat 7	Cat 8
30	12	24	BD30-1DR	283	-	326	326	307	336	314	332
33	12	24	BD33-1DR	297	-	344	344	324	355	331	351
36	12	24	BD36-1DR	306	-	358	357	335	369	343	365

Sequence is not available in this configuration

Sink Base Cabinet - 2 Door

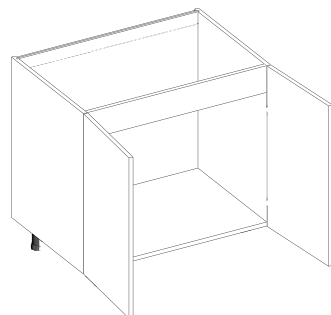

W	H	D	Reference	Cat 1	Cat 2	Cat 3	Cat 4	Cat 5	Cat 6	Cat 7	Cat 8
30	30	24	SB30-2DO	276	-	347	383	337	408	354	398
33	30	24	SB33-2DO	291	-	369	408	357	435	376	425
36	30	24	SB36-2DO	303	-	388	431	375	461	396	449
39	30	24	SB39-2DO	318	-	411	457	397	489	419	477
42	30	24	SB42-2DO	333	-	382	482	417	517	441	504

Sequence is not available in this configuration

Notes:

Sink base cabinets do not include shelves

Sink Base Cabinet - 2 Door 1 False Front

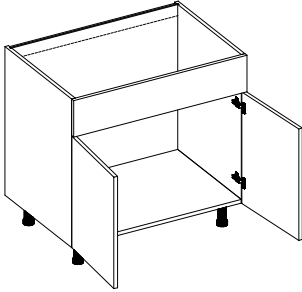

W	H	D	Reference	Cat 1	Cat 2	Cat 3	Cat 4	Cat 5	Cat 6	Cat 7	Cat 8
30	30	24	SB30-2DO1FF	293	314	364	399	353	424	370	414
33	30	24	SB33-2DO1FF	307	331	385	424	373	451	392	441
36	30	24	SB36-2DO1FF	319	345	404	447	391	476	412	465
39	30	24	SB39-2DO1FF	335	363	427	473	413	505	435	493
42	30	24	SB42-2DO1FF	349	379	448	498	433	532	457	519

Notes:

Sink base cabinets do not include shelves

Sink Base Cabinet - 1 Drawer 1 False Front

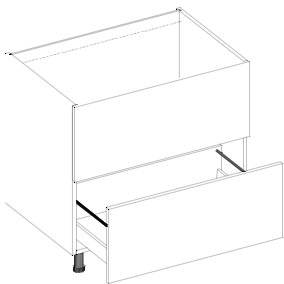

W	H	D	Reference	Cat 1	Cat 2	Cat 3	Cat 4	Cat 5	Cat 6	Cat 7	Cat 8
30	30	24	SB30-2DR	337	359	408	444	398	469	415	459
33	30	24	SB33-2DR	354	378	432	471	420	498	439	488
36	30	24	SB36-2DR	368	394	454	496	441	526	461	515
39	30	24	SB39-2DR	384	412	476	522	462	554	484	542

Notes:

Sink base cabinets do not include shelves

Corner Base Cabinet - 2 Door with Hardware

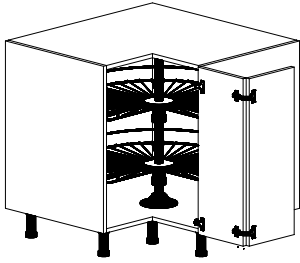

W	H	D	Reference	Cat 1	Cat 2	Cat 3	Cat 4	Cat 5	Cat 6	Cat 7	Cat 8
3636	30	24	LS3636-2DO	681	-	734	761	726	779	-	-

Sequence is not available in this configuration

W	H	D	Reference	Cat 1	Cat 2	Cat 3	Cat 4	Cat 5	Cat 6	Cat 7	Cat 8
3636	30	24	LS3636-2DOFP	-	-	-	-	-	-	682	715

* Finger Pull reference

Notes:

Hardware Included

Corner Base Cabinet - 2 Door

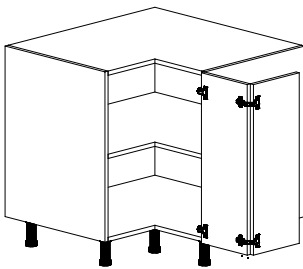

W	H	D	Reference	Cat 1	Cat 2	Cat 3	Cat 4	Cat 5	Cat 6	Cat 7	Cat 8
3333	30	24	EZ3333-2DO	463	-	501	521	495	534	-	-
3636	30	24	EZ3636-2DO	498	-	551	578	543	596	-	-

Sequence is not available in this configuration

W	H	D	Reference	Cat 1	Cat 2	Cat 3	Cat 4	Cat 5	Cat 6	Cat 7	Cat 8
3333	30	24	EZ3333-2DOFP	-	-	-	-	-	-	504	528
3636	30	24	EZ3636-2DOFP	-	-	-	-	-	-	555	588

* Finger Pull reference

Blind Base Cabinet - 1 Door

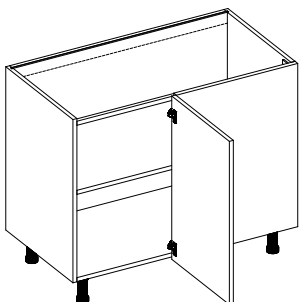

W	H	D	Reference	Cat 1	Cat 2	Cat 3	Cat 4	Cat 5	Cat 6	Cat 7	Cat 8
33	30	24	B33-24DBL	330	-	409	448	397	475	416	465
36	30	24	B36-24DBL	352	-	437	480	424	510	445	499
39	30	24	B39-24DBL	369	-	462	508	448	540	470	528
42	30	24	B42-24DBL	388	-	488	538	473	573	497	560
45	30	24	B45-24DBL	388	-	488	538	473	573	497	560
48	30	24	B48-24DBL	388	-	488	538	473	573	497	560

Sequence is not available in this configuration

Notes:

Fixed panel is 26" 15/16 wide
Important: it is strongly recommended to order a filler for the cabinet that connects to the fixed panel

Base Cabinet Gola - 1 Door

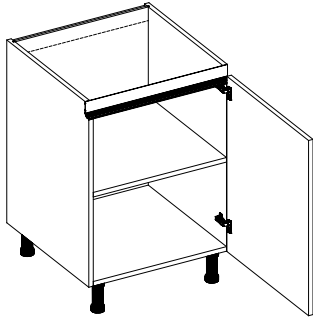

W	H	D	Reference	Cat 1	Cat 2	Cat 3	Cat 4	Cat 5	Cat 6	Cat 7	Cat 8
9	30	24	B9-1DOGO	193	-	213	224	-	-	-	-
12	30	24	B12-1DOGO	208	-	235	249	-	-	-	-
15	30	24	B15-1DOGO	225	-	259	276	-	-	-	-
18	30	24	B18-1DOGO	234	-	275	295	-	-	-	-
21	30	24	B21-1DOGO	252	-	300	323	-	-	-	-
24	30	24	B24-1DOGO	268	-	322	349	-	-	-	-

Sequence is not available in this configuration

Notes:

Gola profile not included.
It needs to be ordered separately

Base Cabinet Gola - 2 Door

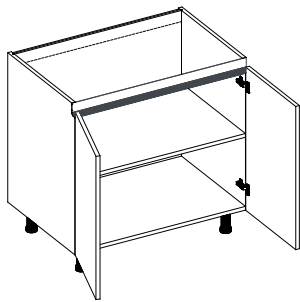

W	H	D	Reference	Cat 1	Cat 2	Cat 3	Cat 4	Cat 5	Cat 6	Cat 7	Cat 8
24	30	24	B24-2DOGO	287	-	341	368	-	-	-	-
27	30	24	B27-2DOGO	303	-	364	394	-	-	-	-
30	30	24	B30-2DOGO	319	-	386	420	-	-	-	-
33	30	24	B33-2DOGO	335	-	409	446	-	-	-	-
36	30	24	B36-2DOGO	356	-	437	478	-	-	-	-
39	30	24	B39-2DOGO	388	-	743	520	-	-	-	-
42	30	24	B42-2DOGO	392	-	487	534	-	-	-	-

Sequence is not available in this configuration

Notes:

Gola profile not included.
It needs to be ordered separately

Base Cabinet Gola - 1 Door Reduced Depth

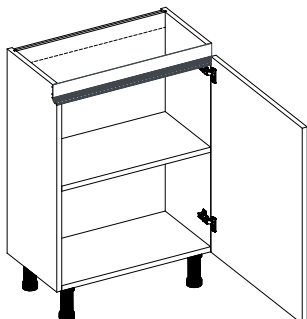

W	H	D	Reference	Cat 1	Cat 2	Cat 3	Cat 4	Cat 5	Cat 6	Cat 7	Cat 8
9	30	24	BRD9-1DOGO	166	-	186	197	-	-	-	-
12	30	24	BRD12-1DOGO	184	-	211	225	-	-	-	-
15	30	24	BRD15-1DOGO	201	-	235	252	-	-	-	-
18	30	24	BRD18-1DOGO	219	-	260	280	-	-	-	-
21	30	24	BRD21-1DOGO	240	-	288	311	-	-	-	-
24	30	24	BRD24-1DOGO	257	-	311	338	-	-	-	-

Sequence is not available in this configuration

Notes:

Gola profile not included.
It needs to be ordered separately

Base Cabinet Gola - 2 Door Reduced Depth

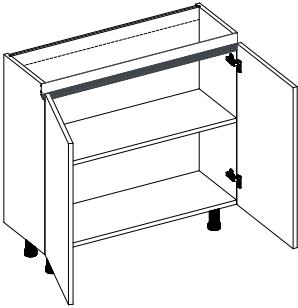

W	H	D	Reference	Cat 1	Cat 2	Cat 3	Cat 4	Cat 5	Cat 6	Cat 7	Cat 8
24	30	24	BRD24-2DOGO	276	-	330	357	-	-	-	-
27	30	24	BRD27-2DOGO	294	-	355	385	-	-	-	-
30	30	24	BRD30-2DOGO	303	-	370	404	-	-	-	-
33	30	24	BRD33-2DOGO	320	-	394	431	-	-	-	-
36	30	24	BRD36-2DOGO	337	-	418	459	-	-	-	-
39	30	24	BRD39-2DOGO	354	-	442	486	-	-	-	-

Sequence is not available in this configuration

Notes:

Gola profile not included.
It needs to be ordered separately

Base Cabinet Gola - 1 Door Spice Rack

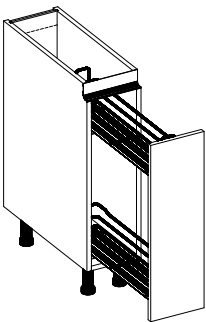

W	H	D	Reference	Cat 1	Cat 2	Cat 3	Cat 4	Cat 5	Cat 6	Cat 7	Cat 8
9	30	24	B9-LDRGO	294	-	314	324	-	-	-	-

Sequence is not available in this configuration

Notes:

Gola profile not included.
It needs to be ordered separately

Base Cabinet Gola - 1 Door Gola Trash Pull Out

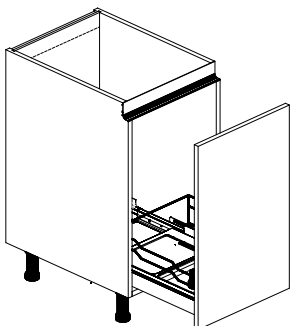

W	H	D	Reference	Cat 1	Cat 2	Cat 3	Cat 4	Cat 5	Cat 6	Cat 7	Cat 8
18	30	24	B18-LDRGO	517	-	557	578	-	-	-	-

Sequence is not available in this configuration

Notes:

Hardware included. Gola profile not included.
It needs to be ordered separately

Base Cabinet Gola - 1 Door 1 Drawer

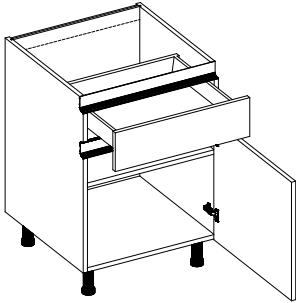

W	H	D	Reference	Cat 1	Cat 2	Cat 3	Cat 4	Cat 5	Cat 6	Cat 7	Cat 8
9	30	24	B9-1DO1DRGO	260	268	286	299	-	-	-	-
12	30	24	B12-1DO1DRGO	275	284	306	321	-	-	-	-
15	30	24	B15-1DO1DRGO	292	303	327	345	-	-	-	-
18	30	24	B18-1DO1DRGO	301	313	341	361	-	-	-	-
21	30	24	B21-1DO1DRGO	318	332	364	387	-	-	-	-
24	30	24	B24-1DO1DRGO	336	351	387	413	-	-	-	-

Notes:

Gola profile not included.
It needs to be ordered separately

Base Cabinet Gola - 2 Door 1 Drawer

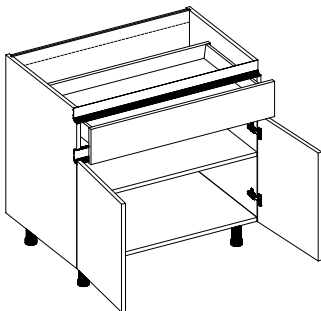

W	H	D	Reference	Cat 1	Cat 2	Cat 3	Cat 4	Cat 5	Cat 6	Cat 7	Cat 8
24	30	24	B24-2DO1DRGO	355	370	406	431	-	-	-	-
27	30	24	B27-2DO1DRGO	372	390	430	459	-	-	-	-
30	30	24	B30-2DO1DRGO	389	409	454	486	-	-	-	-
33	30	24	B33-2DO1DRGO	405	426	476	511	-	-	-	-
36	30	24	B36-2DO1DRGO	430	454	507	546	-	-	-	-
39	30	24	B39-2DO1DRGO	454	479	537	579	-	-	-	-

Notes:

Gola profile not included.
It needs to be ordered separately

Base Cabinet Gola - 2 Drawer

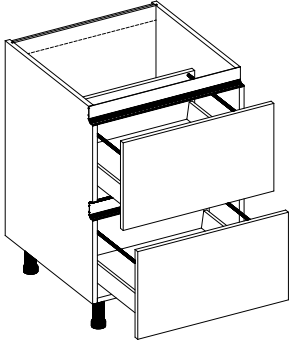

W	H	D	Reference	Cat 1	Cat 2	Cat 3	Cat 4	Cat 5	Cat 6	Cat 7	Cat 8
9	30	24	B9-2DRGO	313	320	336	348	-	-	-	-
15	30	24	B15-2DRGO	328	338	360	376	-	-	-	-
18	30	24	B18-2DRGO	348	360	386	406	-	-	-	-
21	30	24	B21-2DRGO	366	380	411	433	-	-	-	-
24	30	24	B24-2DRGO	384	400	435	461	-	-	-	-
27	30	24	B27-2DRGO	401	418	459	488	-	-	-	-
30	30	24	B30-2DRGO	420	439	484	516	-	-	-	-
33	30	24	B33-2DRGO	440	461	511	546	-	-	-	-
36	30	24	B36-2DRGO	455	478	532	571	-	-	-	-
39	30	24	B39-2DRGO	471	496	555	597	-	-	-	-

Notes:

Gola profile not included.
It needs to be ordered separately

Base Cabinet Gola - 1 Bottom 2 Top Drawer

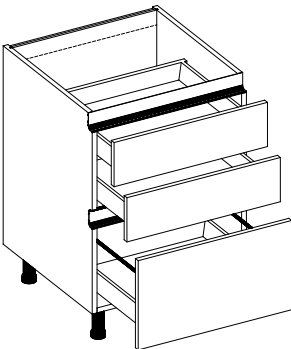

W	H	D	Reference	Cat 1	Cat 2	Cat 3	Cat 4	Cat 5	Cat 6	Cat 7	Cat 8
9	30	24	B9-12DRGO	380	390	414	431	-	-	-	-
12	30	24	B12-12DRGO	379	390	415	433	-	-	-	-
15	30	24	B15-12DRGO	393	405	432	451	-	-	-	-
18	30	24	B18-12DRGO	411	424	453	474	-	-	-	-
21	30	24	B21-12DRGO	427	441	473	495	-	-	-	-
24	30	24	B24-12DRGO	446	461	497	523	-	-	-	-
27	30	24	B27-12DRGO	464	482	522	551	-	-	-	-
30	30	24	B30-12DRGO	485	504	549	581	-	-	-	-
33	30	24	B33-12DRGO	506	528	577	612	-	-	-	-
36	30	24	B36-12DRGO	523	546	600	638	-	-	-	-
39	30	24	B39-12DRGO	540	566	624	665	-	-	-	-

Notes:

Gola profile not included.
It needs to be ordered separately

Base Cabinet Gola - 3 Drawer

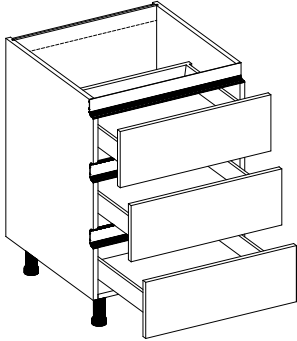

Notes:

Gola profile not included.
It needs to be ordered
separately

W	H	D	Reference	Cat 1	Cat 2	Cat 3	Cat 4	Cat 5	Cat 6	Cat 7	Cat 8
9	30	24	B9-3DRGO	373	384	408	425	-	-	-	-
12	30	24	B12-3DRGO	371	382	406	423	-	-	-	-
15	30	24	B15-3DRGO	381	391	415	433	-	-	-	-
18	30	24	B18-3DRGO	398	409	434	452	-	-	-	-
21	30	24	B21-3DRGO	410	423	453	474	-	-	-	-
24	30	24	B24-3DRGO	435	450	484	508	-	-	-	-
27	30	24	B27-3DRGO	453	470	508	535	-	-	-	-
30	30	24	B30-3DRGO	473	491	529	564	-	-	-	-
33	30	24	B33-3DRGO	494	514	561	594	-	-	-	-
36	30	24	B36-3DRGO	509	532	583	619	-	-	-	-
39	30	24	B39-3DRGO	526	550	605	645	-	-	-	-

Sink Base Cabinet Gola - 2 Door

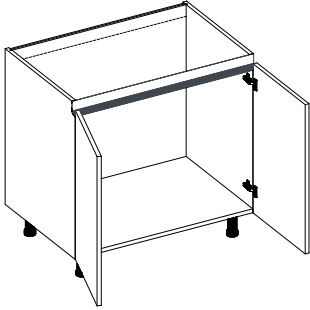

W	H	D	Reference	Cat 1	Cat 2	Cat 3	Cat 4	Cat 5	Cat 6	Cat 7	Cat 8
30	30	24	SB30-2DOGO	311	-	378	412	-	-	-	-
33	30	24	SB33-2DOGO	325	-	399	436	-	-	-	-
36	30	24	SB36-2DOGO	336	-	418	458	-	-	-	-

Sequence is not available in this configuration

Notes:

Sink base cabinets do not include shelves.

Gola profile not included.

It needs to be ordered separately

Sink Base Cabinet Gola - 1 Drawer 1 False Front

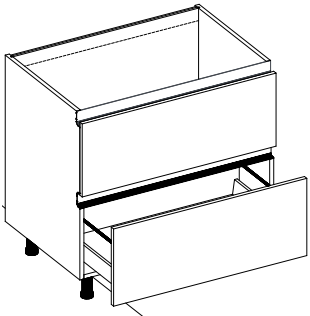

W	H	D	Reference	Cat 1	Cat 2	Cat 3	Cat 4	Cat 5	Cat 6	Cat 7	Cat 8
30	30	24	SB30-2DRGO	348	367	412	444	-	-	-	-
33	30	24	SB33-2DRGO	364	385	434	470	-	-	-	-
36	30	24	SB36-2DRGO	377	401	455	493	-	-	-	-

Notes:

Sink base cabinets do not include shelves.

Gola profile not included.

It needs to be ordered separately

Corner Base Cabinet Gola - 2 Door with Hardware

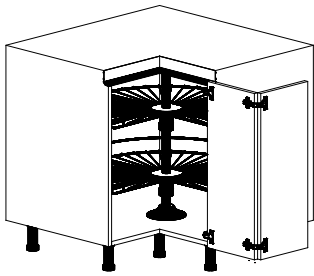

W	H	D	Reference	Cat 1	Cat 2	Cat 3	Cat 4	Cat 5	Cat 6	Cat 7	Cat 8
36	30	24	LS3636-2DOGO	640	-	690	716	-	-	-	-

Sequence is not available in this configuration

Notes:

Hardware Included.

Gola profile not included.

It needs to be ordered separately

Corner Base Cabinet Gola - 2 Door

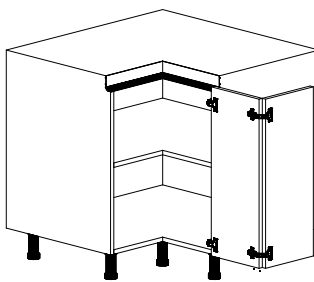

W	H	D	Reference	Cat 1	Cat 2	Cat 3	Cat 4	Cat 5	Cat 6	Cat 7	Cat 8
30	24	24	EZ3333-2DOGO	478	-	515	533	-	-	-	-
30	24	24	EZ3636-2DOGO	513	-	563	589	-	-	-	-

Sequence is not available in this configuration

Notes:

Gola profile not included.

It needs to be ordered separately

Blind Base Cabinet Gola - 1 Door

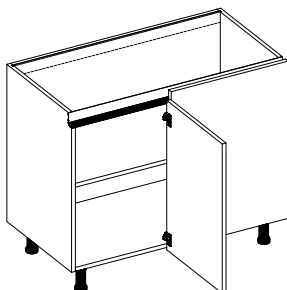

W	H	D	Reference	Cat 1	Cat 2	Cat 3	Cat 4	Cat 5	Cat 6	Cat 7	Cat 8
33	30	24	B33-24DBLGO	344	-	418	455	-	-	-	-
36	30	24	B36-24DBLGO	365	-	446	487	-	-	-	-
39	30	24	B39-24DBLGO	382	-	470	514	-	-	-	-
42	30	24	B42-24DBLGO	400	-	495	543	-	-	-	-
45	30	24	B45-24DBLGO	400	-	495	543	-	-	-	-
48	30	24	B48-24DBLGO	400	-	495	543	-	-	-	-

Sequence is not available in this configuration

Notes:

Fixed panel is 26" 15/16 wide.

Important: it is strongly recommended to order a filler for the cabinet that connects to the fixed panel.

Gola profile not included.

It needs to be ordered separately

Tall Pantry - 1 Door

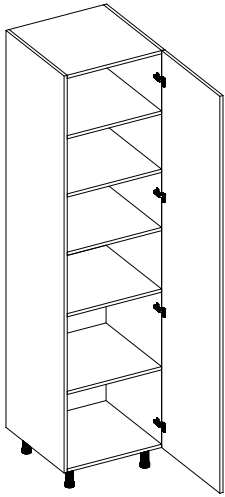

W	H	D	Reference	Cat 1	Cat 2	Cat 3	Cat 4	Cat 5	Cat 6	Cat 7	Cat 8
12	80	24	TP1280-1DO	473	-	548	586	537	612	-	602
15	80	24	TP1580-1DO	517	-	611	659	597	691	-	679
18	80	24	TP1880-1DO	543	-	656	713	639	752	-	737
24	80	24	TP2480-1DO	624	-	776	851	753	904	-	884
12	86	24	TP1286-1DO	503	-	584	624	571	652	-	642
15	86	24	TP1586-1DO	534	-	636	687	620	722	-	709
18	86	24	TP1886-1DO	565	-	687	748	669	791	-	775
24	86	24	TP2486-1DO	651	-	814	895	789	952	-	931
12	92	24	TP1292-1DO	529	-	615	659	602	689	-	677
15	92	24	TP1592-1DO	570	-	679	733	662	771	-	756
18	92	24	TP1892-1DO	609	-	740	805	720	850	-	833
24	92	24	TP2492-1DO	703	-	877	964	851	1025	-	1002

Sequence is not available in this configuration

Notes:

80" & 86" height cabinets include
3 adjustable and 1 fixed shelf.

92" height cabinets include 4 adjustable
and 1 fixed shelf and, includes 5 hinges.

Tall Pantry - 2 Door

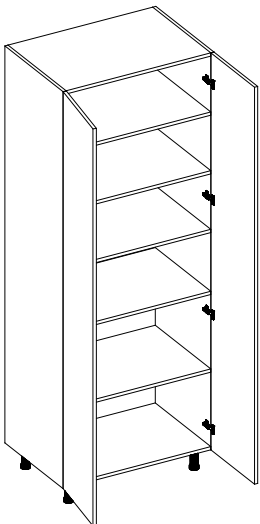

W	H	D	Reference	Cat 1	Cat 2	Cat 3	Cat 4	Cat 5	Cat 6	Cat 7	Cat 8
24	80	24	TP2480-2DO	655	-	806	881	783	933	-	914
27	80	24	TP2780-2DO	697	-	867	951	840	1010	-	988
30	80	24	TP3080-2DO	737	-	926	1020	897	1086	-	1061
36	80	24	TP3680-2DO	822	-	1049	1162	1014	1241	-	1211
24	86	24	TP2486-2DO	682	-	844	925	819	981	-	960
27	86	24	TP2786-2DO	726	-	908	999	880	1063	-	1039
30	86	24	TP3086-2DO	768	-	971	1072	940	1142	-	1116
36	86	24	TP3686-2DO	856	-	1100	1222	1063	1307	-	1275
24	92	24	TP2492-2DO	913	-	913	913	913	913	-	913
27	92	24	TP2792-2DO	788	-	984	1081	954	1149	-	1124
30	92	24	TP3092-2DO	834	-	1051	1159	1018	1235	-	1207
36	92	24	TP3692-2DO	931	-	1192	1323	1153	1413	-	1379

Sequence is not available in this configuration

Notes:

80" & 86" height cabinets include
3 adjustable and 1 fixed shelf.

92" height cabinets include 4 adjustable
and 1 fixed shelf and, includes 5 hinges.

Tall Pantry Utility - 1 Door

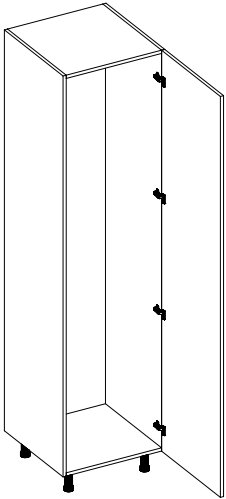

W	H	D	Reference	Cat 1	Cat 2	Cat 3	Cat 4	Cat 5	Cat 6	Cat 7	Cat 8
12	80	24	UTP1280-1DO	428	-	503	541	492	567	-	557
15	80	24	UTP1580-1DO	464	-	558	606	544	638	-	626
18	80	24	UTP1880-1DO	482	-	595	652	578	691	-	676
24	80	24	UTP2480-1DO	546	-	698	773	675	826	-	806
12	86	24	UTP1286-1DO	447	-	528	568	515	596	-	586
15	86	24	UTP1586-1DO	481	-	583	634	567	669	-	656
18	86	24	UTP1886-1DO	504	-	626	687	608	730	-	714
24	86	24	UTP2486-1DO	573	-	736	817	711	874	-	853
12	92	24	UTP1292-1DO	473	-	559	603	546	633	-	621
15	92	24	UTP1592-1DO	504	-	613	667	596	705	-	690
18	92	24	UTP1892-1DO	533	-	664	729	644	774	-	757
24	92	24	UTP2492-1DO	606	-	780	867	754	928	-	905

Sequence is not available in this configuration

Tall Pantry Utility - 2 Door

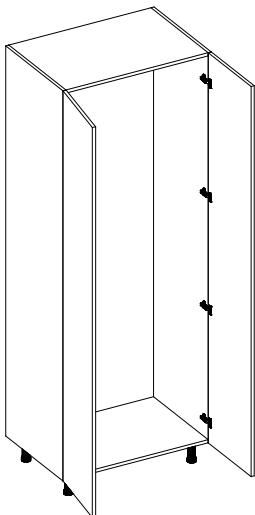

W	H	D	Reference	Cat 1	Cat 2	Cat 3	Cat 4	Cat 5	Cat 6	Cat 7	Cat 8
24	80	24	UTP2480-2DO	577	-	728	803	705	855	-	836
27	80	24	UTP2780-2DO	611	-	781	865	754	924	-	902
30	80	24	UTP3080-2DO	643	-	832	926	803	992	-	967
36	80	24	UTP3680-2DO	708	-	935	1048	900	1127	-	1097
24	86	24	UTP2486-2DO	604	-	766	847	741	903	-	882
27	86	24	UTP2786-2DO	640	-	822	913	794	977	-	953
30	86	24	UTP3086-2DO	674	-	877	978	846	1048	-	1022
36	86	24	UTP3686-2DO	742	-	986	1108	949	1193	-	1161
24	92	24	UTP2492-2DO	816	-	816	816	816	816	-	816
27	92	24	UTP2792-2DO	681	-	877	974	847	1042	-	1017
30	92	24	UTP3092-2DO	717	-	934	1042	901	1118	-	1090
36	92	24	UTP3692-2DO	789	-	1050	1181	1011	1271	-	1237

Sequence is not available in this configuration

Tall Pantry - 1 Bottom 1 Top Door Wall Match

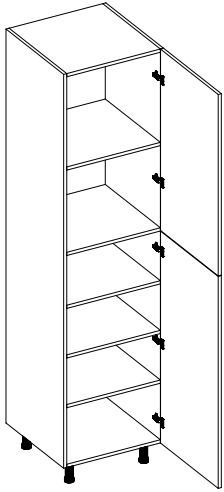

W	H	D	Reference	Cat 1	Cat 2	Cat 3	Cat 4	Cat 5	Cat 6	Cat 7	Cat 8
12	80	24	TP1280-11DO	486	508	561	598	549	624	-	615
15	80	24	TP1580-11DO	530	559	624	671	610	704	-	692
18	80	24	TP1880-11DO	555	590	668	725	651	764	-	750
24	80	24	TP2480-11DO	637	683	788	864	765	916	-	897
12	86	24	TP1286-11DO	504	529	585	626	573	654	-	643
15	80	24	TP1586-11DO	547	578	648	699	633	734	-	721
18	86	24	TP1886-11DO	578	615	700	761	681	803	-	787
24	86	24	TP2486-11DO	665	715	828	910	803	967	-	946
12	92	24	TP1292-11DO	541	568	628	671	615	701	-	690
15	80	24	TP1592-11DO	583	616	691	745	675	783	-	769
18	92	24	TP1892-11DO	622	662	752	817	732	863	-	846
24	92	24	TP2492-11DO	716	769	890	977	863	1037	-	1015

Notes:

80" & 86" height cabinets include
3 adjustable and 1 fixed shelf.

92" height cabinets include 4 adjustable
and 1 fixed shelf.

Tall Pantry - 2 Bottom 2 Top Door Wall Match

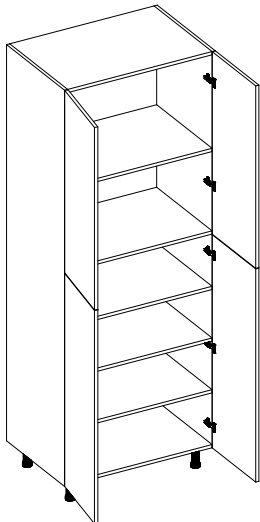

W	H	D	Reference	Cat 1	Cat 2	Cat 3	Cat 4	Cat 5	Cat 6	Cat 7	Cat 8
24	80	24	TP2480-22DO	681	727	831	906	808	959	-	939
27	80	24	TP2780-22DO	722	774	892	976	866	1035	-	1013
30	80	24	TP3080-22DO	763	820	951	1045	922	1111	-	1086
36	80	24	TP3680-22DO	847	916	1074	1187	1039	1265	-	1236
24	86	24	TP2486-22DO	707	757	869	950	845	1006	-	985
27	86	24	TP2786-22DO	751	807	933	1024	906	1088	-	1064
30	86	24	TP3086-22DO	793	855	996	1097	965	1167	-	1141
36	86	24	TP3686-22DO	882	956	1125	1247	1088	1332	-	1300
24	92	24	TP2492-22DO	766	818	939	1025	912	1085	-	1063
27	92	24	TP2792-22DO	814	873	1009	1106	979	1174	-	1149
30	92	24	TP3092-22DO	859	925	1076	1184	1043	1260	-	1232
36	92	24	TP3692-22DO	957	1036	1217	1348	1178	1438	-	1404

Notes:

80" & 86" height cabinets include
3 adjustable and 1 fixed shelf.

92" height cabinets include 4 adjustable
and 1 fixed shelf.

Tall Pantry – 1 Bottom 1 Top Door Base Match

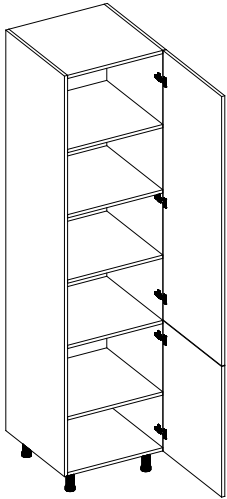

W	H	D	Reference	Cat 1	Cat 2	Cat 3	Cat 4	Cat 5	Cat 6	Cat 7	Cat 8
12	80	24	TP1280-1DO1DO	486	508	561	598	549	624	-	615
15	80	24	TP1580-1DO1DO	530	559	624	671	610	704	-	692
18	80	24	TP1880-1DO1DO	555	590	668	725	651	764	-	750
24	80	24	TP2480-1DO1DO	637	683	788	864	765	916	-	897
12	86	24	TP1286-1DO1DO	504	529	585	626	573	654	-	643
15	86	24	TP1586-1DO1DO	547	578	648	699	633	734	-	721
18	86	24	TP1886-1DO1DO	578	615	700	761	681	803	-	787
24	86	24	TP2486-1DO1DO	664	713	826	908	802	964	-	943
12	92	24	TP1292-1DO1DO	535	561	622	665	609	695	-	684
15	92	24	TP1592-1DO1DO	576	609	685	739	668	777	-	763
18	92	24	TP1892-1DO1DO	616	655	746	811	726	857	-	840
24	92	24	TP2492-1DO1DO	709	762	883	970	857	1031	-	1008

Notes:

80" & 86" height cabinets include 3 adjustable and 1 fixed shelf.

92" height cabinets include 4 adjustable and 1 fixed shelf.

Tall Pantry – 2 Bottom 2 Top Door Base Match

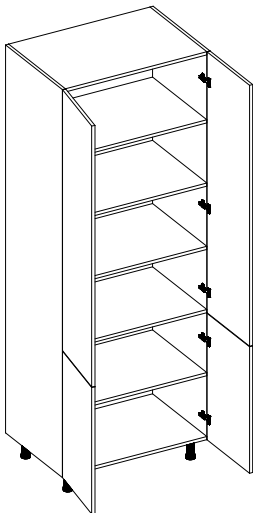

W	H	D	Reference	Cat 1	Cat 2	Cat 3	Cat 4	Cat 5	Cat 6	Cat 7	Cat 8
24	80	24	TP2480-2DO2DO	681	727	831	906	808	959	-	939
27	80	24	TP2780-2DO2DO	722	774	892	976	866	1035	-	1013
30	80	24	TP3080-2DO2DO	763	820	951	1045	922	1111	-	1086
36	80	24	TP3680-2DO2DO	847	916	1074	1187	1039	1265	-	1236
24	86	24	TP2486-2DO2DO	707	757	869	950	845	1006	-	985
27	86	24	TP2786-2DO2DO	751	807	933	1024	906	1088	-	1064
30	86	24	TP3086-2DO2DO	793	855	996	1097	965	1167	-	1141
36	86	24	TP3686-2DO2DO	882	956	1125	1247	1088	1332	-	1300
24	92	24	TP2492-2DO2DO	753	806	926	1013	900	1073	-	1050
27	92	24	TP2792-2DO2DO	801	861	996	1094	967	1162	-	1136
30	92	24	TP3092-2DO2DO	847	913	1064	1172	1031	1247	-	1219
36	92	24	TP3692-2DO2DO	944	1024	1205	1335	1165	1426	-	1392

Notes:

80" & 86" height cabinets include 3 adjustable and 1 fixed shelf.

92" height cabinets include 4 adjustable and 1 fixed shelf.

Tall Pantry - 2 Drawer 1 Door

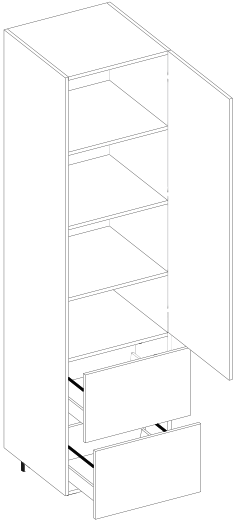

W	H	D	Reference	Cat 1	Cat 2	Cat 3	Cat 4	Cat 5	Cat 6	Cat 7	Cat 8
12	80	24	TP1280-2DR1DO	605	628	680	718	669	744	-	734
15	80	24	TP1580-2DR1DO	654	683	748	795	734	828	-	816
18	80	24	TP1880-2DR1DO	684	718	797	853	780	893	-	878
24	80	24	TP2480-2DR1DO	774	820	925	1001	902	1053	-	1034
12	86	24	TP1286-2DR1DO	624	649	705	745	693	773	-	763
15	86	24	TP1586-2DR1DO	671	702	773	823	757	858	-	845
18	86	24	TP1886-2DR1DO	707	744	828	889	810	931	-	915
24	86	24	TP2486-2DR1DO	801	851	963	1045	939	1101	-	1080
12	92	24	TP1292-2DR1DO	655	681	741	785	728	815	-	803
15	92	24	TP1592-2DR1DO	701	734	809	863	793	901	-	887
18	92	24	TP1892-2DR1DO	744	784	875	940	855	985	-	968
24	92	24	TP2492-2DR1DO	847	900	1021	1107	994	1168	-	1145

Tall Pantry - 2 Drawer 2 Door

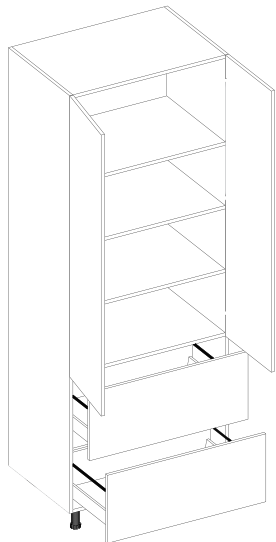

W	H	D	Reference	Cat 1	Cat 2	Cat 3	Cat 4	Cat 5	Cat 6	Cat 7	Cat 8
24	80	24	TP2480-2DR2DO	799	845	950	1025	927	1077	-	1058
27	80	24	TP2780-2DR2DO	845	897	1014	1099	989	1158	-	1136
30	80	24	TP3080-2DR2DO	890	947	1078	1172	1049	1238	-	1213
36	80	24	TP3680-2DR2DO	983	1052	1209	1323	1175	1401	-	1372
24	86	24	TP2486-2DR2DO	826	875	988	1069	963	1125	-	1104
27	86	24	TP2786-2DR2DO	874	930	1056	1147	1029	1211	-	1187
30	86	24	TP3086-2DR2DO	920	982	1123	1224	1092	1295	-	1268
36	86	24	TP3686-2DR2DO	1018	1092	1261	1383	1224	1467	-	1436
24	92	24	TP2492-2DR2DO	872	924	1045	1131	1018	1191	-	1169
27	92	24	TP2792-2DR2DO	924	984	1119	1217	1090	1284	-	1259
30	92	24	TP3092-2DR2DO	974	1040	1191	1299	1158	1375	-	1346
36	92	24	TP3692-2DR2DO	1080	1160	1341	1471	1301	1562	-	1528

Tall Pantry - 1 Bottom 2 Top Drawer 1 Door

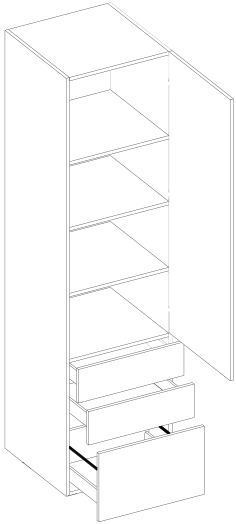

W	H	D	Reference	Cat 1	Cat 2	Cat 3	Cat 4	Cat 5	Cat 6	Cat 7	Cat 8
12	80	24	TP1280-12DR1DO	671	696	755	797	742	826	-	815
15	80	24	TP1580-12DR1DO	717	748	817	866	802	901	-	888
18	80	24	TP1880-12DR1DO	745	780	860	917	842	957	-	942
24	80	24	TP2480-12DR1DO	836	882	987	1062	964	1115	-	1095
12	86	24	TP1286-12DR1DO	689	717	779	824	765	855	-	843
15	86	24	TP1586-12DR1DO	735	767	841	894	825	931	-	917
18	86	24	TP1886-12DR1DO	768	805	891	953	872	995	-	979
24	86	24	TP2486-12DR1DO	863	912	1028	1106	1001	1163	-	1141
12	92	24	TP1292-12DR1DO	720	749	816	863	801	896	-	884
15	92	24	TP1592-12DR1DO	764	798	877	934	860	974	-	959
18	92	24	TP1892-12DR1DO	805	846	937	1003	917	1049	-	1032
24	92	24	TP2492-12DR1DO	909	962	1082	1169	1056	1229	-	1207

Tall Pantry - 1 Bottom 2 Top Drawer 2 Door

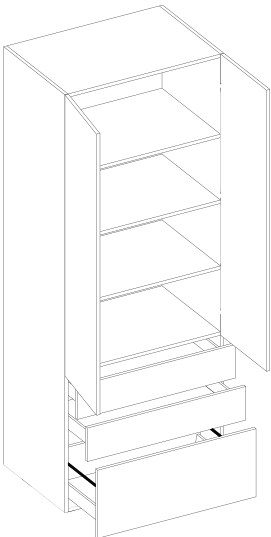

W	H	D	Reference	Cat 1	Cat 2	Cat 3	Cat 4	Cat 5	Cat 6	Cat 7	Cat 8
24	80	24	TP2480-12DR2DO	861	907	1011	1087	989	1139	-	1119
27	80	24	TP2780-12DR2DO	909	960	1078	1162	1052	1221	-	1199
30	80	24	TP3080-12DR2DO	955	1012	1143	1237	1114	1302	-	1278
36	80	24	TP3680-12DR2DO	1051	1120	1277	1390	1243	1469	-	1439
24	86	24	TP2486-12DR2DO	888	937	1049	1130	1025	1186	-	1165
27	86	24	TP2786-12DR2DO	938	993	1120	1210	1092	1274	-	1250
30	86	24	TP3086-12DR2DO	985	1047	1188	1289	1157	1359	-	1333
36	86	24	TP3686-12DR2DO	1086	1160	1329	1450	1292	1535	-	1503
24	92	24	TP2492-12DR2DO	934	986	1106	1193	1080	1253	-	1230
27	92	24	TP2792-12DR2DO	988	1047	1182	1280	1153	1348	-	1322
30	92	24	TP3092-12DR2DO	1039	1105	1255	1364	1223	1439	-	1411
36	92	24	TP3692-12DR2DO	1148	1227	1408	1538	1369	1629	-	1595

Tall Pantry - 2 Bottom 1 Top Drawer 1 Door

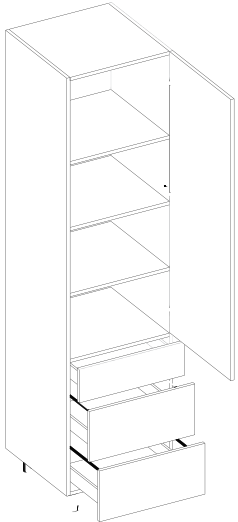

W	H	D	Reference	Cat 1	Cat 2	Cat 3	Cat 4	Cat 5	Cat 6	Cat 7	Cat 8
12	80	24	TP1280-21DR1DO	675	699	756	797	744	825	-	814
15	80	24	TP1580-21DR1DO	722	751	818	866	803	900	-	887
18	80	24	TP1880-21DR1DO	751	786	865	922	848	962	-	947
24	80	24	TP2480-21DR1DO	844	890	995	1070	972	1123	-	1103
12	86	24	TP1286-21DR1DO	694	720	781	824	767	854	-	843
15	86	24	TP1586-21DR1DO	739	770	843	894	827	930	-	917
18	86	24	TP1886-21DR1DO	774	811	896	958	878	1000	-	984
24	86	24	TP2486-21DR1DO	871	920	1033	1114	1009	1171	-	1150
12	92	24	TP1292-21DR1DO	724	753	817	863	803	896	-	884
15	92	24	TP1592-21DR1DO	768	802	879	934	862	973	-	958
18	92	24	TP1892-21DR1DO	812	852	943	1008	923	1054	-	1037
24	92	24	TP2492-21DR1DO	917	970	1090	1177	1064	1237	-	1215

Tall Pantry - 2 Bottom 1 Top Drawer 2 Door

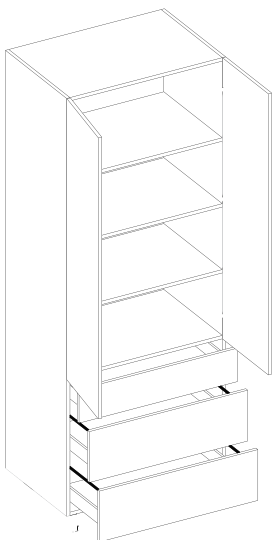

W	H	D	Reference	Cat 1	Cat 2	Cat 3	Cat 4	Cat 5	Cat 6	Cat 7	Cat 8
24	80	24	TP2480-21DR2DO	869	915	1019	1095	997	1147	-	1127
27	80	24	TP2780-21DR2DO	917	968	1086	1171	1060	1229	-	1207
30	80	24	TP3080-21DR2DO	964	1021	1151	1245	1123	1311	-	1286
36	80	24	TP3680-21DR2DO	1061	1129	1287	1399	1252	1478	-	1449
24	86	24	TP2486-21DR2DO	896	945	1057	1138	1033	1194	-	1173
27	86	24	TP2786-21DR2DO	946	1001	1128	1219	1100	1282	-	1258
30	86	24	TP3086-21DR2DO	994	1056	1196	1297	1166	1368	-	1341
36	86	24	TP3686-21DR2DO	1095	1169	1338	1460	1301	1544	-	1512
24	92	24	TP2492-21DR2DO	942	994	1115	1201	1088	1261	-	1239
27	92	24	TP2792-21DR2DO	996	1055	1191	1288	1161	1356	-	1330
30	92	24	TP3092-21DR2DO	1048	1114	1264	1372	1231	1448	-	1419
36	92	24	TP3692-21DR2DO	1158	1237	1418	1548	1378	1638	-	1604

Tall Pantry - 3 Drawer 1 Door

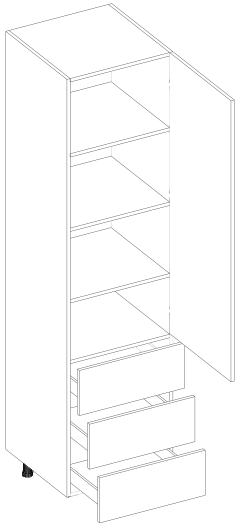

W	H	D	Reference	Cat 1	Cat 2	Cat 3	Cat 4	Cat 5	Cat 6	Cat 7	Cat 8
12	80	24	TP1280-3DR1DO	661	686	743	783	730	812	-	801
15	80	24	TP1580-3DR1DO	705	733	798	845	784	878	-	866
18	80	24	TP1880-3DR1DO	705	739	817	874	800	913	-	898
24	80	24	TP2480-3DR1DO	828	874	979	1054	956	1107	-	1087
12	86	24	TP1286-3DR1DO	680	707	767	811	754	841	-	829
15	86	24	TP1586-3DR1DO	722	753	823	873	808	909	-	895
18	86	24	TP1886-3DR1DO	758	795	880	940	861	983	-	967
24	86	24	TP2486-3DR1DO	855	904	1017	1098	992	1155	-	1133
12	92	24	TP1292-3DR1DO	711	739	804	850	789	882	-	870
15	92	24	TP1592-3DR1DO	751	784	859	913	843	951	-	937
18	92	24	TP1892-3DR1DO	798	838	928	993	908	1038	-	1021
24	92	24	TP2492-3DR1DO	901	954	1074	1161	1048	1221	-	1199

Tall Pantry - 3 Drawer 2 Door

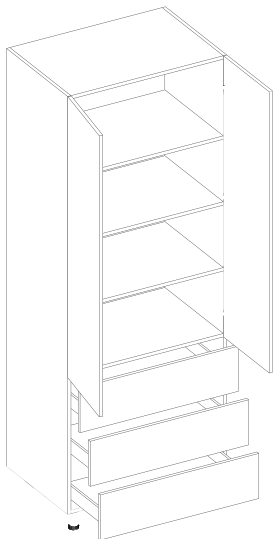

W	H	D	Reference	Cat 1	Cat 2	Cat 3	Cat 4	Cat 5	Cat 6	Cat 7	Cat 8
24	80	24	TP2480-3DR2DO	853	899	1003	1078	981	1131	-	1111
27	80	24	TP2780-3DR2DO	900	952	1069	1154	1044	1213	-	1191
30	80	24	TP3080-3DR2DO	946	1003	1134	1228	1106	1293	-	1269
36	80	24	TP3680-3DR2DO	1042	1111	1268	1381	1233	1459	-	1430
24	86	24	TP2486-3DR2DO	880	929	1041	1122	1017	1178	-	1157
27	86	24	TP2786-3DR2DO	929	985	1111	1202	1084	1265	-	1242
30	86	24	TP3086-3DR2DO	977	1038	1179	1280	1148	1350	-	1324
36	86	24	TP3686-3DR2DO	1076	1150	1319	1441	1282	1525	-	1494
24	92	24	TP2492-3DR2DO	926	978	1098	1185	1072	1245	-	1222
27	92	24	TP2792-3DR2DO	979	1039	1174	1271	1144	1339	-	1314
30	92	24	TP3092-3DR2DO	981	1047	1198	1306	1165	1381	-	1353
36	92	24	TP3692-3DR2DO	1139	1218	1399	1529	1359	1620	-	1586

Single Oven - 1 Bottom 1 Top Door

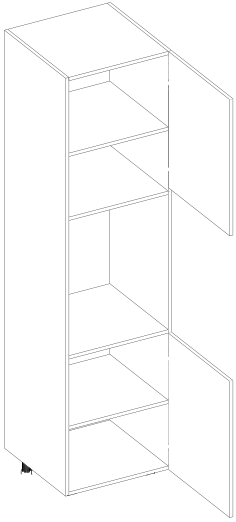

W	H	D	Reference	Cat 1	Cat 2	Cat 3	Cat 4	Cat 5	Cat 6	Cat 7	Cat 8
24	80	24	SO2480-1DO1DO	544	-	646	697	631	733	655	720
24	86	24	SO2486-1DO1DO	570	-	684	741	667	781	694	766
24	92	24	SO2492-1DO1DO	624	-	749	812	730	855	760	839

Sequence is not available in this configuration

Notes:

A 6" filler is provided with aluminum edge for appliance adjustments

The 80" and 86" unit height, doesn't include the top adjustable shelf.

Single Oven - 2 Bottom 2 Top Door

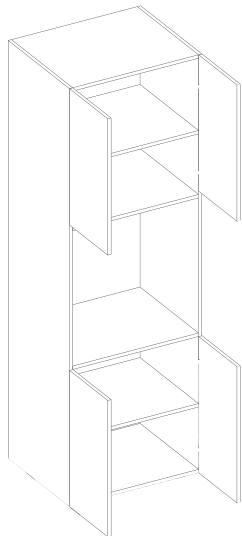

W	H	D	Reference	Cat 1	Cat 2	Cat 3	Cat 4	Cat 5	Cat 6	Cat 7	Cat 8
24	80	24	SO2480-2DO2DO	588	-	690	741	675	777	699	763
30	80	24	SO3080-2DO2DO	649	-	777	841	758	885	788	869
24	86	24	SO2486-2DO2DO	615	-	728	785	711	824	738	810
30	86	24	SO3086-2DO2DO	680	-	822	893	800	942	834	924
24	92	24	SO2492-2DO2DO	661	-	786	849	767	892	797	876
30	92	24	SO3092-2DO2DO	733	-	890	968	866	1022	903	1002

Sequence is not available in this configuration

Notes:

A 6" filler is provided with aluminum edge for appliance adjustments

The 80" and 86" unit height, doesn't include the top adjustable shelf.

Single Oven - 2 Drawer 1 Door

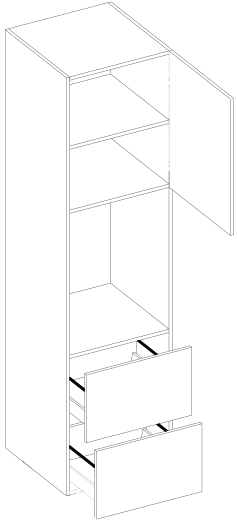

W	H	D	Reference	Cat 1	Cat 2	Cat 3	Cat 4	Cat 5	Cat 6	Cat 7	Cat 8
24	80	24	SO2480-2DR1DO	688	719	790	841	774	877	799	863
24	86	24	SO2486-2DR1DO	714	749	828	885	811	924	838	910
24	92	24	SO2492-2DR1DO	761	799	886	949	867	992	897	976

Notes:

A 6" filler is provided with aluminum edge for appliance adjustments

The 80" and 86" unit height, doesn't include the top adjustable shelf.

Single Oven - 2 Drawer 2 Door

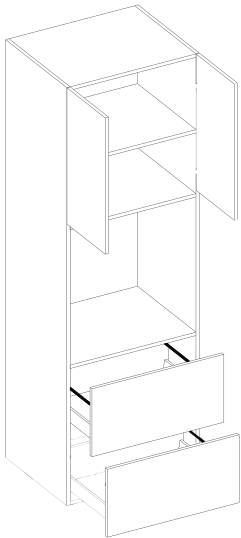

W	H	D	Reference	Cat 1	Cat 2	Cat 3	Cat 4	Cat 5	Cat 6	Cat 7	Cat 8
24	80	24	SO2480-2DR2DO	707	738	809	860	793	895	818	882
30	80	24	SO3080-2DR2DO	776	815	904	968	885	1013	915	996
24	86	24	SO2486-2DR2DO	733	768	847	903	829	943	857	928
30	86	24	SO3086-2DR2DO	807	850	949	1020	927	1069	961	1051
24	92	24	SO2492-2DR2DO	780	818	905	967	886	1011	916	994
30	92	24	SO3092-2DR2DO	861	908	1017	1095	993	1149	1030	1129

Notes:

A 6" filler is provided with aluminum edge for appliance adjustments

The 80" and 86" unit height, doesn't include the top adjustable shelf.

Single Oven - 1 Bottom 2 Top Drawer 1 Door

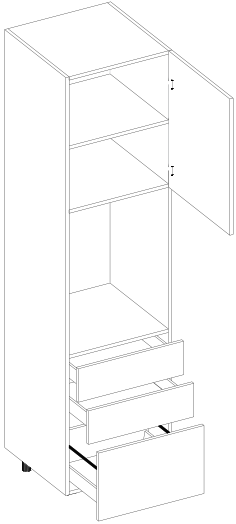

W	H	D	Reference	Cat 1	Cat 2	Cat 3	Cat 4	Cat 5	Cat 6	Cat 7	Cat 8
24	80	24	SO2480-12DR1DO	750	781	852	903	836	938	861	925
24	86	24	SO2486-12DR1DO	776	811	890	947	873	986	900	971
24	92	24	SO2492-12DR1DO	823	861	948	1010	929	1054	959	1038

Notes:

A 6" filler is provided with aluminum edge for appliance adjustments

The 80" and 86" unit height, doesn't include the top adjustable shelf.

Single Oven - 1 Bottom 2 Top Drawer 2 Door

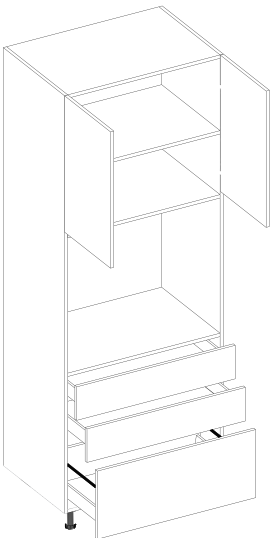

W	H	D	Reference	Cat 1	Cat 2	Cat 3	Cat 4	Cat 5	Cat 6	Cat 7	Cat 8
24	80	24	SO2480-12DR2DO	769	800	870	921	855	957	879	944
30	80	24	SO3080-12DR2DO	842	880	969	1033	950	1077	980	1060
24	86	24	SO2486-12DR2DO	795	830	908	965	891	1004	918	990
30	86	24	SO3086-12DR2DO	872	915	1014	1085	992	1134	1026	1115
24	92	24	SO2492-12DR2DO	842	880	966	1029	947	1072	977	1056
30	92	24	SO3092-12DR2DO	926	973	1082	1160	1058	1214	1095	1194

Notes:

A 6" filler is provided with aluminum edge for appliance adjustments

The 80" and 86" unit height, doesn't include the top adjustable shelf.

Single Oven - 2 Bottom 1 Top Drawer 1 Door

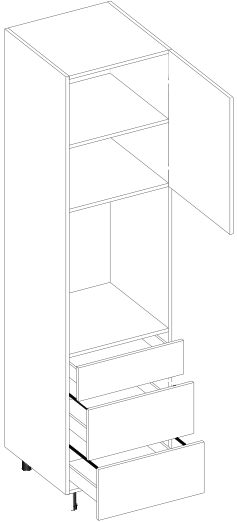

W	H	D	Reference	Cat 1	Cat 2	Cat 3	Cat 4	Cat 5	Cat 6	Cat 7	Cat 8
24	80	24	SO2480-21DR1DO	758	789	860	911	844	946	869	933
24	86	24	SO2486-21DR1DO	784	819	898	955	881	994	908	979
24	92	24	SO2492-21DR1DO	831	869	956	1018	937	1062	967	1046

Notes:

A 6" filler is provided with aluminum edge for appliance adjustments

The 80" and 86" unit height, doesn't include the top adjustable shelf.

Single Oven - 2 Bottom 1 Top Drawer 2 Door

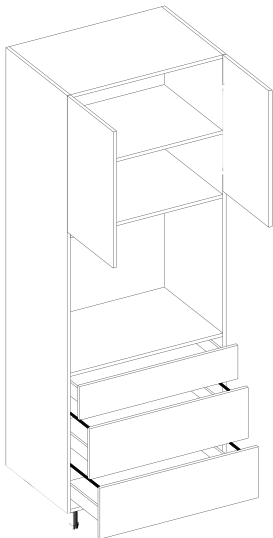

W	H	D	Reference	Cat 1	Cat 2	Cat 3	Cat 4	Cat 5	Cat 6	Cat 7	Cat 8
24	80	24	SO2480-21DR2DO	777	808	878	929	863	965	887	952
30	80	24	SO3080-21DR2DO	850	889	978	1041	958	1086	989	1069
24	86	24	SO2486-21DR2DO	803	838	916	973	899	1013	926	998
30	86	24	SO3086-21DR2DO	881	924	1022	1093	1001	1143	1035	1124
24	92	24	SO2492-21DR2DO	850	888	974	1037	956	1080	985	1064
30	92	24	SO3092-21DR2DO	934	982	1090	1168	1067	1223	1104	1202

Notes:

A 6" filler is provided with aluminum edge for appliance adjustments

The 80" and 86" unit height, doesn't include the top adjustable shelf.

Single Oven - 3 Drawer 1 Door

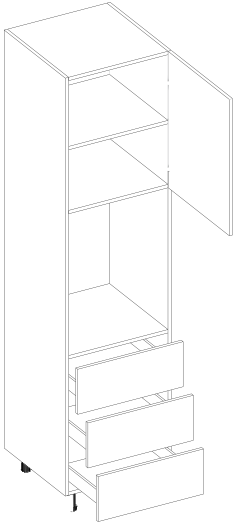

W	H	D	Reference	Cat 1	Cat 2	Cat 3	Cat 4	Cat 5	Cat 6	Cat 7	Cat 8
24	80	24	SO2480-3DR1DO	742	773	844	895	828	930	852	917
24	86	24	SO2486-3DR1DO	768	803	882	939	864	978	892	963
24	92	24	SO2492-3DR1DO	815	853	940	1002	921	1046	951	1030

Notes:

A 6" filler is provided with aluminum edge for appliance adjustments

The 80" and 86" unit height, doesn't include the top adjustable shelf.

Single Oven - 3 Drawer 2 Door

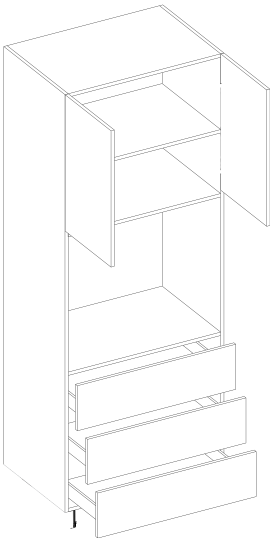

W	H	D	Reference	Cat 1	Cat 2	Cat 3	Cat 4	Cat 5	Cat 6	Cat 7	Cat 8
24	80	24	SO2480-3DR2DO	769	803	880	935	863	973	889	959
30	80	24	SO3080-3DR2DO	833	872	960	1024	941	1068	971	1052
24	86	24	SO2486-3DR2DO	787	822	900	957	883	996	910	982
30	86	24	SO3086-3DR2DO	863	907	1005	1076	984	1125	1017	1107
24	92	24	SO2492-3DR2DO	834	872	958	1021	939	1064	969	1048
30	92	24	SO3092-3DR2DO	917	964	1073	1151	1049	1205	1086	1185

Notes:

A 6" filler is provided with aluminum edge for appliance adjustments

The 80" and 86" unit height, doesn't include the top adjustable shelf.

Single Oven - 2 Drawer 1 or 2 Flip UP

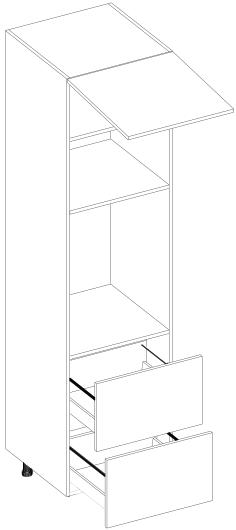

W	H	D	Reference	Cat 1	Cat 2	Cat 3	Cat 4	Cat 5	Cat 6	Cat 7	Cat 8
24	80	24	SO2480-2DR1FT	821	852	923	975	908	1010	932	997
30	80	24	SO3080-2DR1FT	891	930	1019	1083	1000	1128	1030	1111
24	86	24	SO2486-2DR1FT	848	883	962	1019	945	1058	972	1044
30	86	24	SO3086-2DR1FT	922	965	1064	1136	1043	1185	1077	1167
24	92	24	SO2492-2DR2FT	1296	1334	1421	1483	1402	1527	1432	1510
30	92	24	SO3092-2DR2FT	1410	1458	1567	1645	1543	1699	1580	1679

Notes:

A 6" filler is provided with aluminum edge for appliance adjustments

Single Oven - 1 Bottom 2 Top Drawer 1 or 2 Flip UP

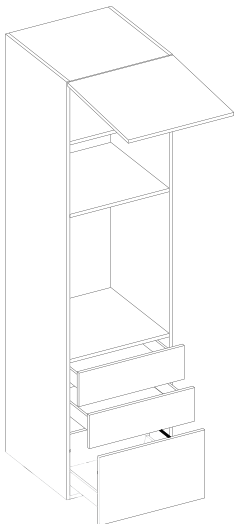

W	H	D	Reference	Cat 1	Cat 2	Cat 3	Cat 4	Cat 5	Cat 6	Cat 7	Cat 8
24	80	24	SO2480-12DR1FT	883	914	985	1036	970	1072	994	1059
30	80	24	SO3080-12DR1FT	944	983	1072	1136	1053	1180	1083	1164
24	86	24	SO2486-12DR1FT	910	945	1024	1081	1007	1120	1034	1105
30	86	24	SO3086-12DR1FT	975	1019	1117	1188	1096	1238	1130	1219
24	92	24	SO2492-12DR2FT	1358	1396	1482	1545	1464	1588	1493	1572
30	92	24	SO3092-12DR2FT	1474	1522	1630	1708	1606	1762	1644	1742

Notes:

A 6" filler is provided with aluminum edge for appliance adjustments

Single Oven - 2 Bottom 1 Top Drawer 1 or 2 Flip UP

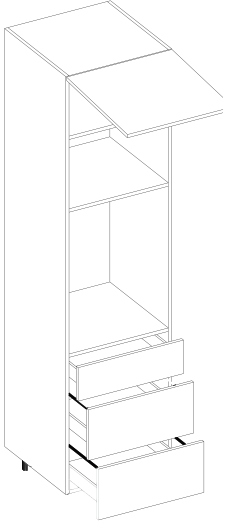

W	H	D	Reference	Cat 1	Cat 2	Cat 3	Cat 4	Cat 5	Cat 6	Cat 7	Cat 8
24	80	24	SO2480-21DR1FT	891	922	993	1044	978	1080	1002	1067
30	80	24	SO3080-21DR1FT	952	991	1080	1144	1061	1188	1091	1172
24	86	24	SO2486-21DR1FT	918	953	1032	1089	1015	1128	1042	1113
30	86	24	SO3086-21DR1FT	983	1027	1125	1196	1104	1246	1138	1227
24	92	24	SO2492-21DR2FT	1366	1404	1490	1553	1472	1596	1501	1580
30	92	24	SO3092-21DR2FT	1484	1532	1640	1718	1616	1772	1654	1752

Notes:

A 6" filler is provided with aluminum edge for appliance adjustments

Single Oven - 3 Drawer 1 or 2 Flip UP

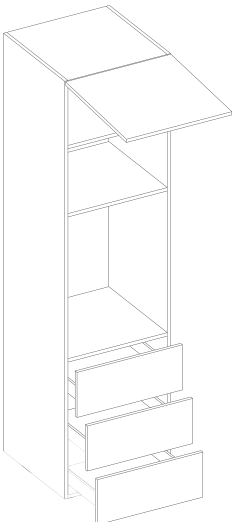

W	H	D	Reference	Cat 1	Cat 2	Cat 3	Cat 4	Cat 5	Cat 6	Cat 7	Cat 8
24	80	24	SO2480-3DR1FT	875	906	977	1028	962	1064	986	1050
30	80	24	SO3080-3DR1FT	947	986	1075	1139	1056	1183	1086	1167
24	86	24	SO2486-3DR1FT	902	937	1016	1073	999	1112	1026	1097
30	86	24	SO3086-3DR1FT	979	1022	1120	1191	1099	1241	1133	1222
24	92	24	SO2492-3DR2FT	1420	1458	1544	1607	1525	1650	1555	1634
30	92	24	SO3092-3DR2FT	1467	1514	1623	1701	1599	1755	1636	1735

Notes:

A 6" filler is provided with aluminum edge for appliance adjustments

Combination Oven – 1 Drawer 1 Door

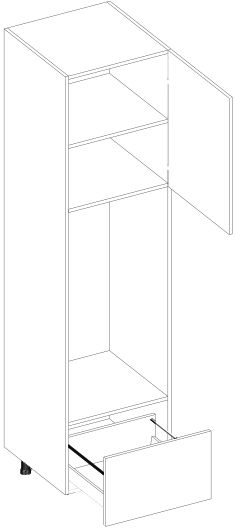

W	H	D	Reference	Cat 1	Cat 2	Cat 3	Cat 4	Cat 5	Cat 6	Cat 7	Cat 8
24	80	24	CO2480-1DR1DO	580	-	654	691	643	717	661	707
24	86	24	CO2486-1DR1DO	607	-	692	735	679	765	700	754
24	92	24	CO2492-1DR1DO	654	-	750	799	736	833	759	820

Sequence is not available in this configuration

Notes:

A 6" filler is provided with aluminum edge for appliance adjustments

The 80" and 86" unit height, doesn't include the top adjustable shelf.

Combination Oven – 1 Drawer 2 Door

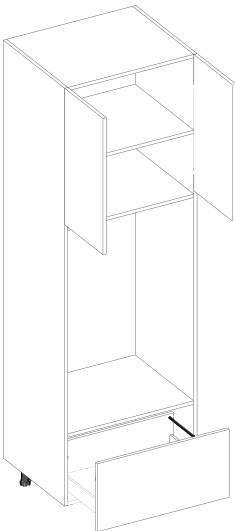

W	H	D	Reference	Cat 1	Cat 2	Cat 3	Cat 4	Cat 5	Cat 6	Cat 7	Cat 8
24	80	24	CO2480-1DR2DO	599	-	673	710	662	736	679	726
30	80	24	CO3080-1DR2DO	657	-	750	796	736	828	758	816
24	86	24	CO2486-1DR2DO	626	-	711	754	698	783	718	772
30	86	24	CO3086-1DR2DO	688	-	795	848	778	885	804	871
24	92	24	CO2492-1DR2DO	672	-	769	817	754	851	777	838
30	92	24	CO3092-1DR2DO	742	-	862	923	844	965	873	949

Sequence is not available in this configuration

Notes:

A 6" filler is provided with aluminum edge for appliance adjustments

The 80" and 86" unit height, doesn't include the top adjustable shelf.

Combination Oven - 1 Drawer 1 or 2 Flip Up

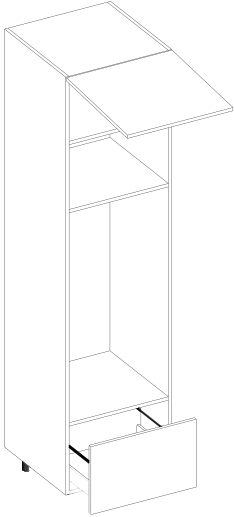

W	H	D	Reference	Cat 1	Cat 2	Cat 3	Cat 4	Cat 5	Cat 6	Cat 7	Cat 8
24	80	24	CO2480-1DR1FT	714	-	788	825	777	851	794	841
30	80	24	CO3080-1DR1FT	773	-	865	911	851	943	873	931
24	86	24	CO2486-1DR1FT	741	-	826	869	813	899	834	888
30	86	24	CO3086-1DR1FT	803	-	910	963	894	1001	919	987
24	92	24	CO2492-1DR2FT	1118	1148	1215	1263	1200	1297	1223	1284
30	92	24	CO3092-1DR2FT	1218	1258	1342	1416	1330	1462	1362	1445

Sequence is not available in 80 and 86 heights

Notes:

A 6" filler is provided with aluminum edge for appliance adjustments

The 80" and 86" unit height, doesn't include the top adjustable shelf.

Double Oven - 1 Drawer 1 Door

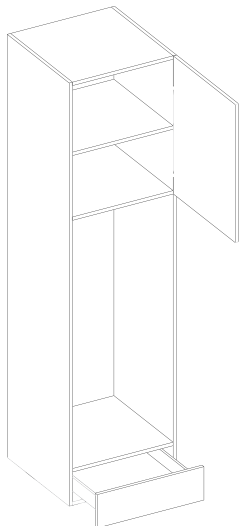

W	H	D	Reference	Cat 1	Cat 2	Cat 3	Cat 4	Cat 5	Cat 6	Cat 7	Cat 8
24	80	24	DO2480-1DR1DO	569	-	617	641	610	658	621	652
24	86	24	DO2486-1DR1DO	584	-	655	691	645	716	662	706
24	92	24	DO2492-1DR1DO	631	-	713	755	701	783	721	773

Sequence is not available in this configuration

Notes:

A 6" filler is provided with aluminum edge for appliance adjustments

The 80" and 86" unit height, doesn't include the top adjustable shelf.

Double Oven - 1 Drawer 2 Door

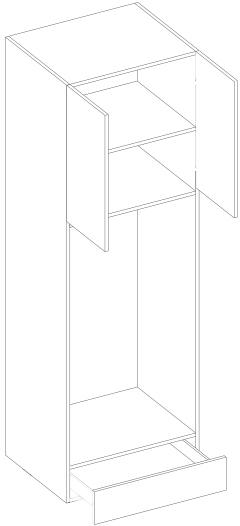

W	H	D	Reference	Cat 1	Cat 2	Cat 3	Cat 4	Cat 5	Cat 6	Cat 7	Cat 8
24	80	24	DO2480-1DR2DO	577	-	636	666	627	686	641	679
30	80	24	DO3080-1DR2DO	631	-	705	742	694	768	711	758
24	86	24	DO2486-1DR2DO	603	-	674	709	663	734	680	725
30	86	24	DO3086-1DR2DO	661	-	750	794	736	825	757	813
24	92	24	DO2492-1DR2DO	650	-	732	773	720	802	739	791
30	92	24	DO3092-1DR2DO	715	-	818	869	802	905	826	891

Sequence is not available in this configuration

Notes:

A 6" filler is provided with aluminum edge for appliance adjustments

The 80" and 86" unit height, doesn't include the top adjustable shelf.

Double Oven - 1 Drawer 1 or 2 Flip Up

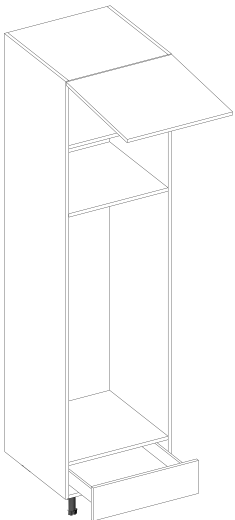

W	H	D	Reference	Cat 1	Cat 2	Cat 3	Cat 4	Cat 5	Cat 6	Cat 7	Cat 8
24	80	24	DO2480-1DR1FT	691	-	751	781	742	801	756	794
30	80	24	DO3080-1DR1FT	746	-	820	857	809	883	827	874
24	86	24	DO2486-1DR1FT	718	-	789	825	779	850	796	840
30	86	24	DO3086-1DR1FT	776	-	865	910	852	940	873	929
24	92	24	DO2492-1DR2FT	1096	1121	1178	1219	1166	1248	1185	1237
30	92	24	DO3092-1DR2FT	1194	1226	1297	1349	1282	1384	1306	1371

Sequence is not available in 80 and 86 heights

Notes:

A 6" filler is provided with aluminum edge for appliance adjustments.

Floating Vanity Base - 1 Door

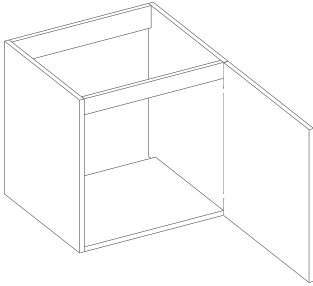

W	H	D	Reference	Cat 1	Cat 2	Cat 3	Cat 4	Cat 5	Cat 6	Cat 7	Cat 8
12	24	21	FVB1224-1DO	167	-	190	201	187	209	192	206
18	24	21	FVB1824-1DO	188	-	222	239	217	251	225	247
24	24	21	FVB2424-1DO	208	-	253	276	246	292	257	286

Sequence is not available in this configuration

Notes:

Hanging hardware included

Floating Vanity Base - 2 Door

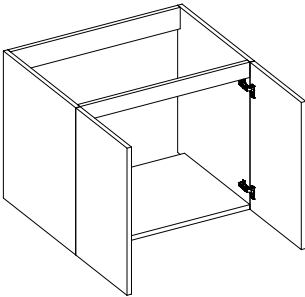

W	H	D	Reference	Cat 1	Cat 2	Cat 3	Cat 4	Cat 5	Cat 6	Cat 7	Cat 8
24	24	21	FVB2424-2DO	227	-	272	295	265	310	276	304
30	24	21	FVB3024-2DO	248	-	305	333	296	353	310	346
36	24	21	FVB3624-2DO	270	-	338	372	328	396	344	387

Sequence is not available in this configuration

Notes:

Hanging hardware included

Floating Vanity Base - 2 Drawer

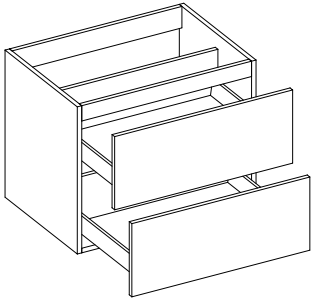

W	H	D	Reference	Cat 1	Cat 2	Cat 3	Cat 4	Cat 5	Cat 6	Cat 7	Cat 8
12	24	21	FVB1224-2DR	274	281	296	309	294	317	299	314
18	24	21	FVB1824-2DR	302	312	336	353	331	365	339	360
24	24	21	FVB2424-2DR	329	343	374	397	367	413	378	407
30	24	21	FVB3024-2DR	358	375	415	443	406	463	420	455
36	24	21	FVB3624-2DR	387	408	455	489	445	513	461	504

Notes:

Hanging hardware included

Floating Vanity Base - 2 Drawer (U Shape)

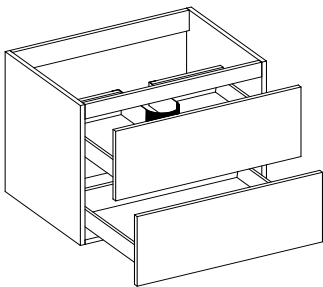

W	H	D	Reference	Cat 1	Cat 2	Cat 3	Cat 4	Cat 5	Cat 6	Cat 7	Cat 8
24	24	21	FVB2424-2DRU	385	399	430	453	423	469	434	463
30	24	21	FVB3024-2DRU	414	431	471	499	462	519	476	511
36	24	21	FVB3624-2DRU	443	464	511	545	501	569	517	560

Notes:

Hanging hardware included

Vanity Base - 1 Door

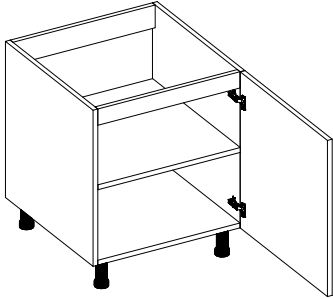

W	H	D	Reference	Cat 1	Cat 2	Cat 3	Cat 4	Cat 5	Cat 6	Cat 7	Cat 8
12	28	21	VB1228-1DO	170	-	196	209	192	219	198	215
18	28	21	VB1828-1DO	193	-	233	253	227	267	237	262
24	28	21	VB2428-1DO	217	-	270	297	262	315	275	308

Sequence is not available in this configuration

Vanity - 2 Door

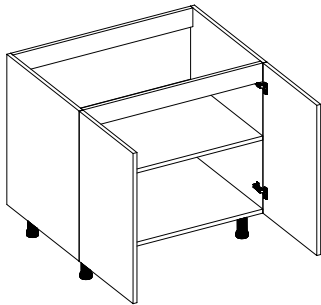

W	H	D	Reference	Cat 1	Cat 2	Cat 3	Cat 4	Cat 5	Cat 6	Cat 7	Cat 8
24	28	21	VB2428-2DO	236	-	289	315	281	334	293	327
30	28	21	VB3028-2DO	261	-	328	361	318	384	333	375
36	28	21	VB3628-2DO	286	-	366	406	354	433	373	423

Sequence is not available in this configuration

Vanity Base - 1 Door 1 Drawer

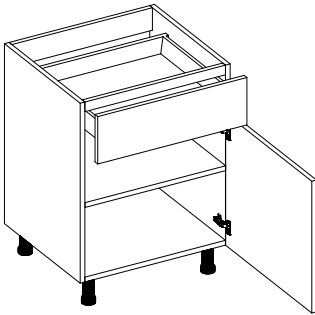

W	H	D	Reference	Cat 1	Cat 2	Cat 3	Cat 4	Cat 5	Cat 6	Cat 7	Cat 8
12	28	21	VB1228-1DO1DR	238	247	268	284	264	295	272	291
18	28	21	VB1828-1DO1DR	261	274	301	323	296	338	306	332
28	28	21	VB2428-1DO1DR	287	303	338	366	332	385	345	378

Vanity Base - 2 Drawer

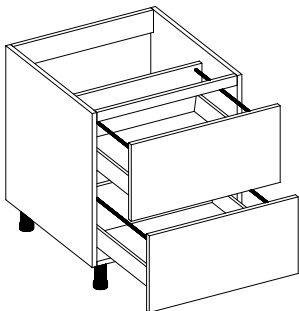

W	H	D	Reference	Cat 1	Cat 2	Cat 3	Cat 4	Cat 5	Cat 6	Cat 7	Cat 8
12	28	21	VB1228-2DR	290	298	316	329	312	338	318	335
18	28	21	VB1828-2DR	322	334	362	381	356	395	365	390
24	28	21	VB2428-2DR	354	370	407	434	399	452	412	445
30	28	21	VB3028-2DR	389	409	436	488	445	511	461	502
36	28	21	VB3628-2DR	422	446	502	541	489	569	508	559

Vanity Base - 2 Drawer (U Shape)

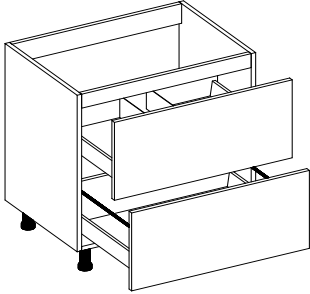

W	H	D	Reference	Cat 1	Cat 2	Cat 3	Cat 4	Cat 5	Cat 6	Cat 7	Cat 8
24	28	21	VB2428-2DRU	402	418	455	481	447	500	460	493
30	28	21	VB3028-2DRU	439	459	505	538	495	561	511	553
36	28	21	VB3628-2DRU	472	497	552	592	540	619	559	609

Vanity Base - 1 Bottom 2 TOP Drawer

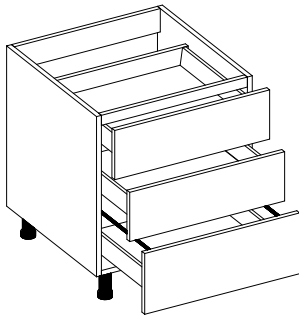

W	H	D	Reference	Cat 1	Cat 2	Cat 3	Cat 4	Cat 5	Cat 6	Cat 7	Cat 8
12	28	21	VB1228-12DR	356	367	390	410	386	423	395	418
18	28	21	VB1828-12DR	384	397	427	449	421	464	431	458
28	28	21	VB2428-12DR	416	432	469	495	461	514	474	507

Vanity Base - 3 Drawer

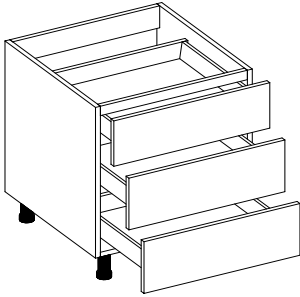

W	H	D	Reference	Cat 1	Cat 2	Cat 3	Cat 4	Cat 5	Cat 6	Cat 7	Cat 8
12	28	21	VB1228-3DR	347	358	382	399	377	411	385	407
18	28	21	VB1828-3DR	374	386	413	433	407	446	416	441
28	28	21	VB2428-3DR	408	424	461	487	453	506	466	499

Vanity Base - 2 Door 1 False Front

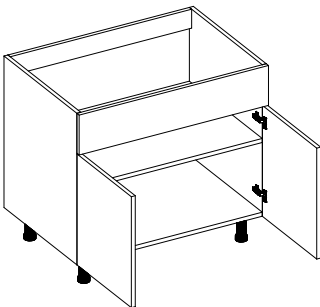

W	H	D	Reference	Cat 1	Cat 2	Cat 3	Cat 4	Cat 5	Cat 6	Cat 7	Cat 8
24	28	21	VB2428-2DO1FF	252	268	303	331	297	350	310	343
30	28	21	VB3028-2DO1FF	278	298	344	377	334	400	350	391
36	28	21	VB3628-2DO1FF	303	327	382	421	370	449	389	439

Fillers

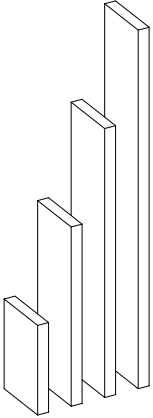

W	H	Reference	Cat 1	Cat 3
6	24	F006024	12	24
6	28	F006028	14	28
6	30	F006030	15	30
6	36	F006036	18	35
6	42	F006042	21	41
6	79.5	F006080	39	78
6	85.5	F006086	42	83
6	91.5	F006092	45	89
6	96	F006096	47	93
6	107	F006107	53	104
6	30.75	F006307	16	30
6	36.75	F006367	18	36
6	42.75	F006427	21	42
3	24	F003024	36	70

W	H	Reference	Cat 1	Cat 3
3	28	F003028	36	70
3	30	F003030	36	70
3	36	F003036	36	70
3	42	F003042	36	70
3	79.5	F003080	59	116
3	85.5	F003086	63	125
3	91.5	F003092	68	133
3	96	F003096	71	140
3	107	F003107	79	156
3	30.75	F003307	36	70
3	36.75	F003367	36	70
3	42.75	F003427	36	70
23.875	6	F0002386	12	24
29.875	6	F0002986	15	29

Panels

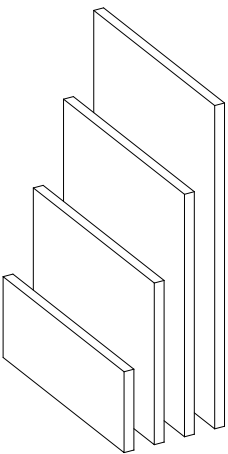

W	H	Reference	Cat 1	Cat 3
14	30	F014030	35	68
14	36	F014036	42	82
14	42	F014042	48	95
14	30.75	F014307	36	70
14	36.75	F014367	42	84
14	42.75	F014427	49	97
22	24	F022024	44	86
22	32.5	F022325	59	116
25	30	F025030	62	122

W	H	Reference	Cat 1	Cat 3
25	34.5	F025345	71	140
25	84	F025084	172	340
25	90	F025090	184	364
25	96	F025096	196	388
32	84	F032084	220	434
32	90	F032090	235	465
32	96	F032096	251	496
42	103	F042103	353	699

Toe Kick

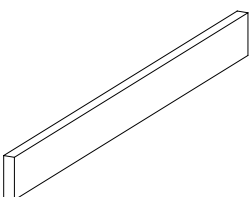

W	H	Reference	Cat 1	Cat 3
107	4.5	F005107	40	78

W	H	Reference	PVC Toe Kick
156	4.5	AZO000000003	29

ACCESSORIES

ITEM	REFERENCE	DESCRIPTION	PRICE	
DRAWER · Quick Motion				
Drawer S	DRQMS0001	Soft closing. Grey color. Height size: Small	\$39	*
Drawer M	DRQMT0001	Soft closing. Grey color. Height size: Medium	\$44	*
Interior Drawer · Rollout	DRQMR0001	Soft closing. Grey color. Height size: Small	\$59	
DRAWER · Evolution				
Drawer S	DREVOS001	Soft closing and slim shape. Antracite color. Height size: Small	\$33	**
Drawer M	DREVOT001	Soft closing and slim shape. Antracite color. Height size: Medium	\$39	**
Interior Drawer · Rollout	DREVOR001	Soft closing and slim shape. Antracite color. Height size: Small	\$113	
DRAWER · Blum				
Drawer M	DRBLM0001	Soft closing and slim shape. Antracite color. Height size: Small	\$98	**
Drawer C	DRBLC0001	Soft closing and slim shape. Antracite color. Height size: Medium	\$125	**
Drawer F	DRBLF0001	Soft closing and slim shape. Antracite color. Height size: Tall	\$186	**
Interior Drawer M · Rollout	DRBLMR001	Soft closing and slim shape. Antracite color. Height size: Small	\$217	
DRAWER · Blum Push to open				
Drawer M	DRBLPM001	Soft closing and slim shape. Antracite color. Height size: Small	\$161	**
Drawer C	DRBLCP001	Soft closing and slim shape. Antracite color. Height size: Medium	\$188	**
Drawer F	DRBLFP001	Soft closing and slim shape. Antracite color. Height size: Tall	\$248	**
GOLA PROFILE				
J Profile	AVA000000011	Anodized Aluminum J Gola Profile. Size 4m (13.12')	\$56	
C Profile	AVA000000012	Anodized Aluminum C Gola Profile. Size 4m (13.12')	\$73	
J End Cover set	AVA000000013	End cover set for J gola profile. Zamac in silver finish	\$5	
C End Cover set	AVA000000014	End cover set for C gola Profile. Zamac in silver finish	\$3	
Metal bracket	AVA000000015	Gola profile connecting brackets. One unit.	\$1.5	
J Interior corner	AVA000000016	90° Interior corner connector for J gola profile	\$4	

NOTES

* Price is included inside those modulations that have drawers.

** Price is a SUBSTITUTION Price, and to be added when the selected drawer replace the standard drawer.

MODIFICATIONS

Modifications in width, height and depth are available on any cabinet as per the following rates.

- Width modification \$ 50.
- Height & Depth modification \$ 75.
- Pantry / Oven Width modification \$ 80.
- Pantry / Oven Height & Depth modification \$ 110.

CABINET ARCHITECTURE



TERMS & CONDITIONS

GENERAL

All prices are FOB your nearest Lioher Location.

Lioher only sells to authorized dealers or distributors.

LEAD TIME

Orders will be processed in 3 to 5 weeks. Standard orders being 3 weeks, and orders with modifications, fingerpull, cava or gola will be 5 weeks.

CANCELLATIONS AND CHANGES

All orders are manufactured to meet your specifications. No charges or cancellations will be accepted after the order is confirmed.

SHIPPING & DELIVERY

All destinations must be tractor/trailer accessible, or a \$150 limited access fee will be applied. The driver is only responsible for placing the pallet on ground.

Residential deliveries are available for a \$150 fee. The residential classifications are based on city zoning. Therefore, it is possible to have a commercial property in a residential area. In this case, the delivery would be considered residential and is subject to the 'Residential Delivery' fees and conditions.

The Shipping charges cover one delivery attempt. The customer is responsible for any additional shipping and handling charges for delivery failure due to customer circumstances. Re-delivery fees are \$100 per each delivery attempt.

A responsible party must be present to inspect, inventory, and sign off on delivery. Any orders require signed acknowledgement upon receiving. If the number of pallets delivered does not match the number listed in the BOL a careful inspection of packaging condition is vital for freight claims purpose. Even if you are not sure the contents inside contain damage due to the exterior's condition, please indicate on the BOL. Do not reject damaged items.

PICK UP ORDERS

Orders not picked up within 5 business days will be subject to a storage charge of \$25 per pallet per day. Orders not picked up within 10 business days will be subject to a storage charges and additional re-stocking fees of 20%.

CLAIMS PROCESS & POLICY

Claims are processed online. The claim platform allows you to submit all necessary information conveniently from your smartphone (or computer), making it easier to submit detailed pictures when a problem occurs. After a claim submission, we will review and reply in 24 to 48 hours. No claim will be accepted without the proper online submission.

Freight claims for obvious damage or shortage can only be accepted when indicated on the BOL and submitted within 24 hours of the delivery.

All damages must be documented and reported upon opening the boxes. Items that have been assembled or installed cannot be claimed as damaged. NO labor, transportation or other costs accrued during the installation of our products are covered. This includes, but is not limited to, items that may be flawed or have become damaged in transit.

FAQ

How do I place a Custom by Lioher Order?

Clients can place orders with one of LIOHER's order form's.

All orders should be submitted to your Inside sales / customer service representative.

Are the cabinets CARB 2 / TSCA Title VI certified?

Yes, all our cabinets and components are 100% in compliance with the regulatory guidelines for composite wood products.

What type of materials are used in the construction of the cabinet boxes?

Our cabinets boxes, the Aquabox®, are produced with the highest quality moisture resistant particle board and, antibacterial treatment. The AQUABOX features 18mm sides, top, bottom and shelves and an 8mm back. All sides are edge banded to provide the highest resistance to humidity.

How is the interior of the cabinet finished?

All sides of the box, exterior and interior, are finished with a thermosfused melamine in a soft linen design. Panels are required to finish the exposed ends.

Are the cabinets strong enough to support a granite top?

Our Aquabox® cabinets construction ensures the strength required to support granite, concrete or any other countertop material that you may select. No additional cabinet reinforcement is required.

Are the cabinets waterproof?

Our Aquabox® cabinets are water resistant which mean that under normal use conditions, they have a higher level of resistance to water and humidity than standard cabinets.

What forms of payment do you accept?

We accept all major credit cards (Visa, American Express, MasterCard and Discover), Check, and Paypal.

Do you offer credit terms?

LIOHER offer's a line of credit to approved applicants.

What is your return policy?

All custom kitchens are final sale, no products can be returned. Please see the "Claims process & Policy" section of our Terms & Conditions page for details.

How do we ship your cabinetry?

Orders will be shipped via dedicated truck or LTL.

How do I clean my cabinets?

Use a Non abrasive cloth with a mild solution of non detergent soap. Cabinets should be dried immediately after cleaning.

WARRANTY & CONTACT



WARRANTY TERMS

Lioher enterprise corp. Warrants it's cabinetry, doors drawer fronts, and hardware of manufacturing defects for a period of Five (5) years. The warranty period begins from purchase date (Proof of Purchase is required).

The warranty is not transferable and only applicable to product used for residential purposes. Representatives of Lioher enterprise do not have the authority to change or enlarge this warranty.

The warranty does not cover normal wear and tear, damage or defects caused by accidents, misuse, abuse, or lack of necessary maintenance; nor does it cover alteration, modification, improper installation, improper handling / storage, environmental conditions, nor any labor expenses.

Lioher enterprise corp. may elect to repair or replace with a functionally equivalent product any of the covered items by this warranty. Some replacement parts are subject to availability and may differ from original parts received. Return of defective product may be required for a replacement to be issued. Repair parts or replacement parts are at the expense of Lioher enterprise corp. but customer shall bear all other expenses. These other expenses may include, but are not limited to, cost of removal and re-installation of product, labor expenses and transportation.

Environmental factors, including but not limited to artificial / natural light, moisture, cleaners, smoke, etc, may cause the darkening or mellowing of a cabinet over time. It is a natural process and can be expected. This warranty does not cover the natural aging or darkening / mellowing of the products.

This warranty is valid only in the United States of America and Canada and is not transferable. All implied warranties are limited in duration to the shorter of the period provided by law or the period of this warranty. To the extent permitted by law, this warranty excludes special, incidental, or consequential damages. Some states do not allow the exclusion or limitations of incidental or consequential damages or limitations on how long an implied warranty lasts, so the above limitations or exclusions may not apply to you. This warranty gives you specific legal rights; you may have other rights which vary from state to state.

CONTACT

Miami Lakes

13939 NW 60th Ave Miami Lakes, FL 33014.

Phone: 305-685-0005

contactus@lioher.com

Las Vegas

4060 Frehner Rd., Bldg. #100 – North Las Vegas, NV 89030.

Phone: 702-507-0503

contactus@lioher.com

Pompano Beach

1718 West Atlantic Blvd, Pompano Beach, FL 33069.

Phone: 954-678-2203

contactus@lioher.com

Auburndale

525 Recker Hwy. Auburndale, FL 33823.

Phone: 863-510-7969

contactus@lioher.com



Feel the Innovation

Need samples?



www.lioher.com |  [lioherusa](https://www.instagram.com/lioherusa)